



REDWOOD COUNTY ENVIRONMENTAL OFFICE

PO BOX 130
REDWOOD FALLS
MINNESOTA 56283
PH: 507-637-4023

*Planning & Zoning • Parks & Trails • GIS
Aquatic Invasive Species • Septic Inspector
Drainage Inspector • Agricultural Inspector*

NOTICE OF PUBLIC HEARING

An *Animal Confinement Feedlot Conditional Use Permit Application* has been filed by Kyle Christensen pursuant to Minnesota Statute 116.07 subd. 7(a) and Section 17, Subd. 3 and Section 25 of Redwood County Zoning Ordinance, for the construction of a new swine feedlot. The proposed feedlot will include one total confinement wean to finish barn with under floor concrete liquid manure storage. The feedlot will have 2480 head of swine between 55 and 300 pounds (744 state Animal Units, or 992 county Animal Units), on the following described property, situated in the County of Redwood, State of Minnesota, to wit:

Southwest Quarter of the Northwest Quarter (SW1/4 NW1/4) of
Section 14, Township 111 North, Range 38 West, Granite Rock Township.

A public hearing thereon will be held before the Redwood County Planning Commission at the regularly scheduled Planning Commission meeting starting at 1:00 o'clock p.m. on Monday, the 11th day of April, 2016, at the Board Room of the Redwood County Government Center located at 403 South Mill Street, Redwood Falls, MN 56283.

If you have any comments or questions regarding this matter, please contact the Redwood County Environmental Office by telephone at (507) 637-4023 or in writing at *Redwood County Environmental Office, P.O. Box 130, Redwood Falls, MN 56283*.

DATED: March 29th, 2016

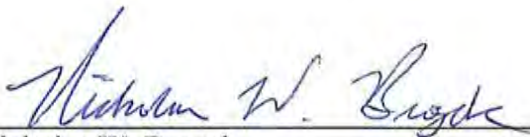

Nicholas W. Brozek
Land Use & Zoning Supervisor
Redwood County Environmental Office

GRANITE ROCK TWP

LAND OWNER

T 111 N

R 38 W

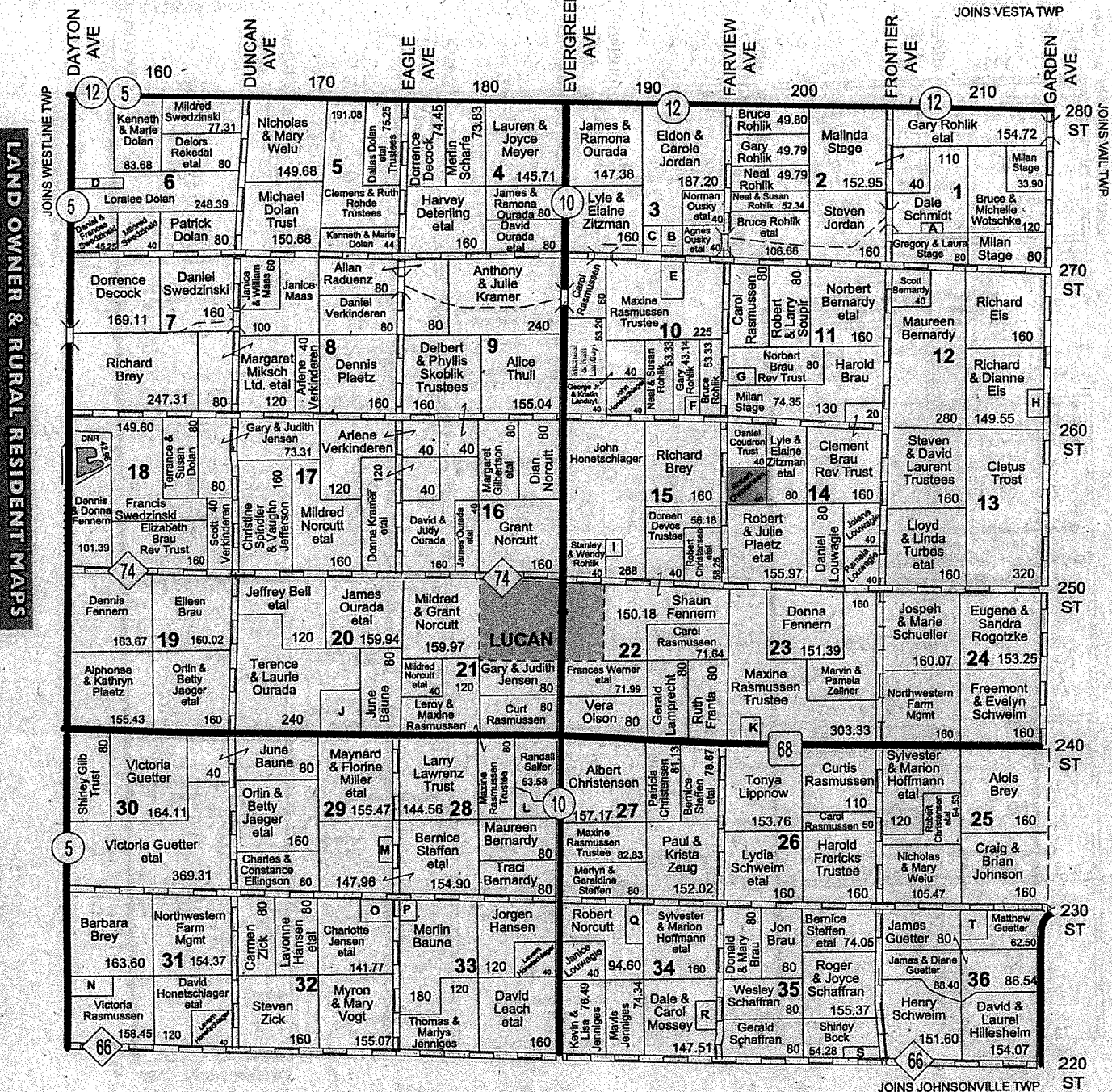

Small Tracts

- Section 1 A Andrew & Kacy Plaetz - 10
- Section 3 B Clarence Fixsen etal - 20
- Section 6 D Clayton Rosa etal - 10.07
- Section 10 E Ted Suss - 15
- Section 11 G Norbert Bernardy etal - 10
- Section 12 H David Eis - 10.45
- Section 15 I John & Suzanne Honetschlager - 12
- Section 20 J James Ourada etal - 20
- Section 23 K Thomas & Elaine Moore - 16.70
- Section 28 L Curtis Rasmussen - 22.80
- Section 29 M Merlyn & Geraldine Steffen - 12.04
- Section 31 N RNJ Trust - 14.78
- Section 32 O Alphonse & Kathryn Plaetz - 18.23
- Section 33 P Daniel Baune - 20
- Section 34 Q Dian Norcutt - 20
- Section 35 R Gregg & Celia Paskewitz - 12.49
- Section 36 T Matthew & Paula Guetter - 17.50

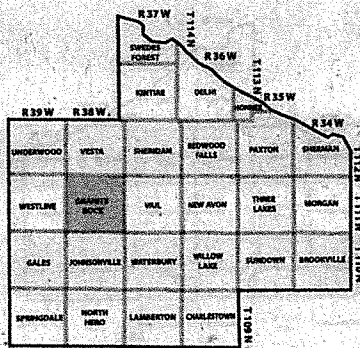



Redwood County

www.co.redwood.mn.us

Animal Confinement Feedlot Conditional Use Permit Application

Permit #: 5-16 Date: 3/15/2016

Proposed Location of Feedlot Operation:

Address: Fairview Ave City: Lucan State: MN Zip: 56255
House # Street Name

Parcel #: 54-014-2040 Township: Granite Rock Section: 14 Twp #: T-111-N Range: R-38-W

Information about the Operation:

General description of feedlot operation (including type and number of animal units, barns, and manure storage plan):

2480 head ween to finish swine barn with 8 foot deep concrete underfloor manure storage pit.

Legal Description of Proposed Feedlot Location:

SW1/4 NW1/4

Information about the Land Owner:

First Name: Robert Last Name: Christensen Phone: (507) 828-8558

Address: 250th St City: Lucan State: MN Zip: 56255

If the applicant is not the owner of the land, please specify the type of agreement the applicant has with the owner of the land at the proposed site:

Site / Plan Information:

Zoning District: Agricultural

Soil Type 1: Storden - Estherville - Ves loams 6 to 12 % slopes, eroded

Soil Type 2: Canisteo Clay loam

Water source for the site: Well Water If other, please explain: _____

Drainage System: Perimeter Tile If other, please explain: _____

Estimated water use:

Animal 1

Animal Type: Swine, Between 55 and 300 pounds

gallons/day/animal x number of animals on site x number of days present
 = gallons/yr/site

Animal 2

Animal Type: _____

gallons/day/animal x number of animals on site x number of days present
 = gallons/yr/site

Animal 3

Animal Type: _____

gallons/day/animal x number of animals on site x number of days present
 = gallons/yr/site

Total Gallons:

Proposed Building(s) Information: (Please enter dimensions in feet)

Building 1:	Width: 102	Length: 200	Height: 21	Sidewall Height: 8	Sidewall Thickness: .7
Building 2:	Width:	Length:	Height:	Sidewall Height:	Sidewall Thickness:
Building 3:	Width:	Length:	Height:	Sidewall Height:	Sidewall Thickness:
Building 4:	Width:	Length:	Height:	Sidewall Height:	Sidewall Thickness:

Each building will have a minimum setback from every road right-of-way of: 67 feet

Estimated date for beginning construction: 6/1/2016 Estimated completion date: 9/30/2016

General Contractor:

Name: RBC or Reeves of Sioux Falls City: _____ State: MN

Feedlot Operator:

Complete this section only if the feedlot operator will be different from the "applicant". If the operator is not a natural person(s), you must also provide documentation of the operator's legal identity.

First Name: Kyle Last Name: Christensen Phone: (507) 828-3285

Address: 19426 250th St City: Lucan State: MN Zip: 56255

Applicant Information:

Note: If the applicant is not one natural person, requested information and signature(s) must be provided for each partner/associate/co-applicant and must include documentation of each co-applicant's legal identity and the legal relationship between them. Each partner/associate/co-applicant must sign or affirm the application before it will be accepted for consideration.

First Name: Kyle Last Name: Christensen

Business: _____

Address: 19426 250th St City: Lucan State: MN Zip: 56255

Home Phone: _____ Cell Phone: (507) 828-3285

List any additional applicants:

I affirm that the forgoing information is true and accurate. I understand that if any portion of this information is false or materially misleading, any conditional use permit issued in reliance upon this information is voidable at the election of Redwood County.

Applicant(s) Signature(s):  Date: 3-15-16

Office Use Only * The section below is to be filled out by the Environmental Office Staff

CUP permit fee: \$700.00 Receipt #: 951817

Completed Application Acceptance Date: 3-16-16 Date Approved:

Commission Action:	County Board Action:
Approved: _____ Date: _____	Approved: _____ Date: _____
Disapproved: _____ Date: _____	Disapproved: _____ Date: _____

Permit # _____

Please add the following items to the map:

1. New Structure(s)
2. Septic System
3. Well

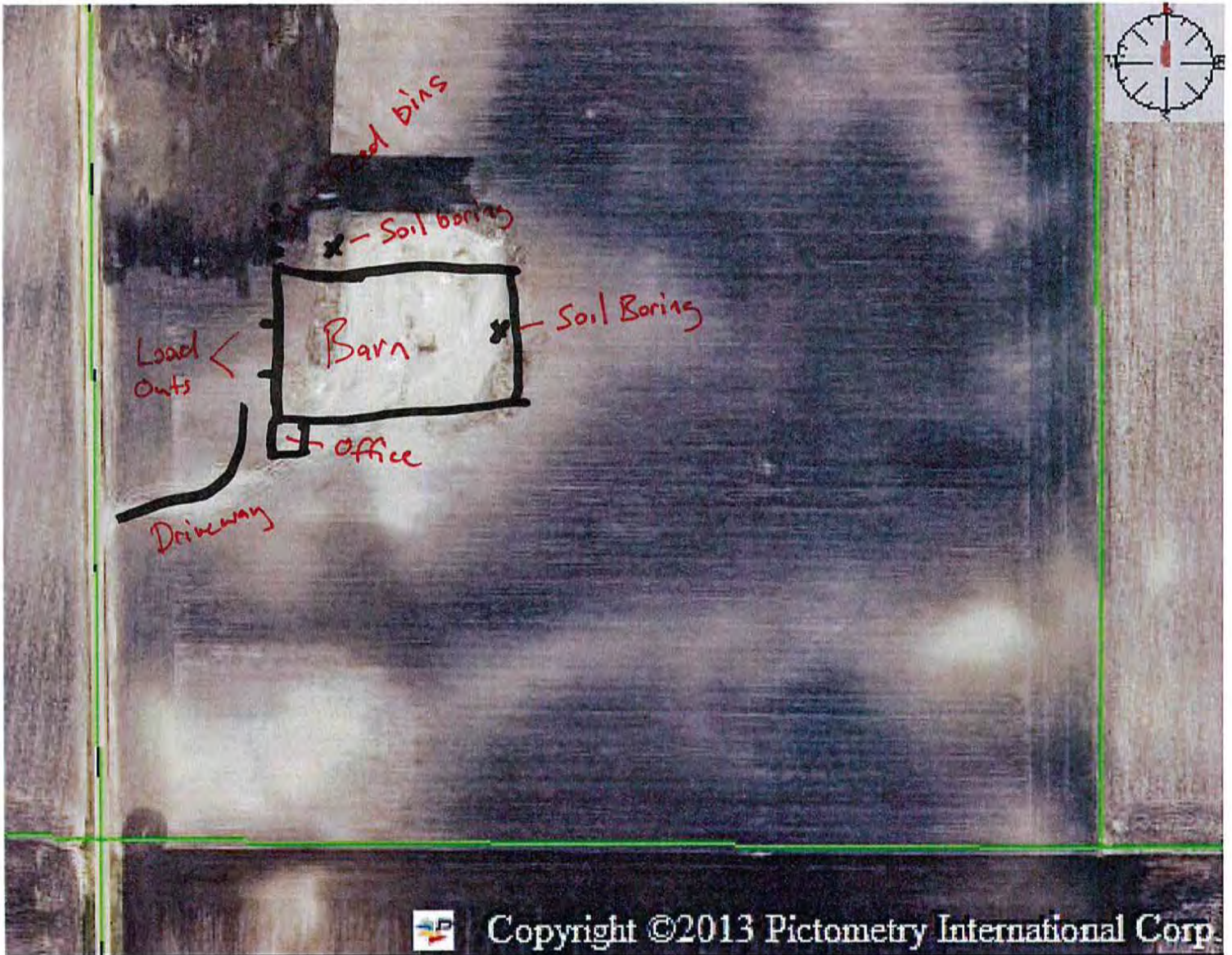

I affirm that the forgoing information is true and accurate. I understand that if any portion of this information is false or misleading, any zoning or land use permit issued in reliance upon this information is voidable at the election of the Redwood County Zoning Administrator.

Landowner Signature:  Date: 3-15-16

Administrator Signature: _____ Date: _____

Redwood County Zoning Administrator

Christensen neighbor map



Christensen area map

Legend

- Address_points
- Roads
- parcels
- township & city boundaries
- section lines
- Ditches
 - County Tile
- OPEN_, JURISDICTION
 - Open Ditch

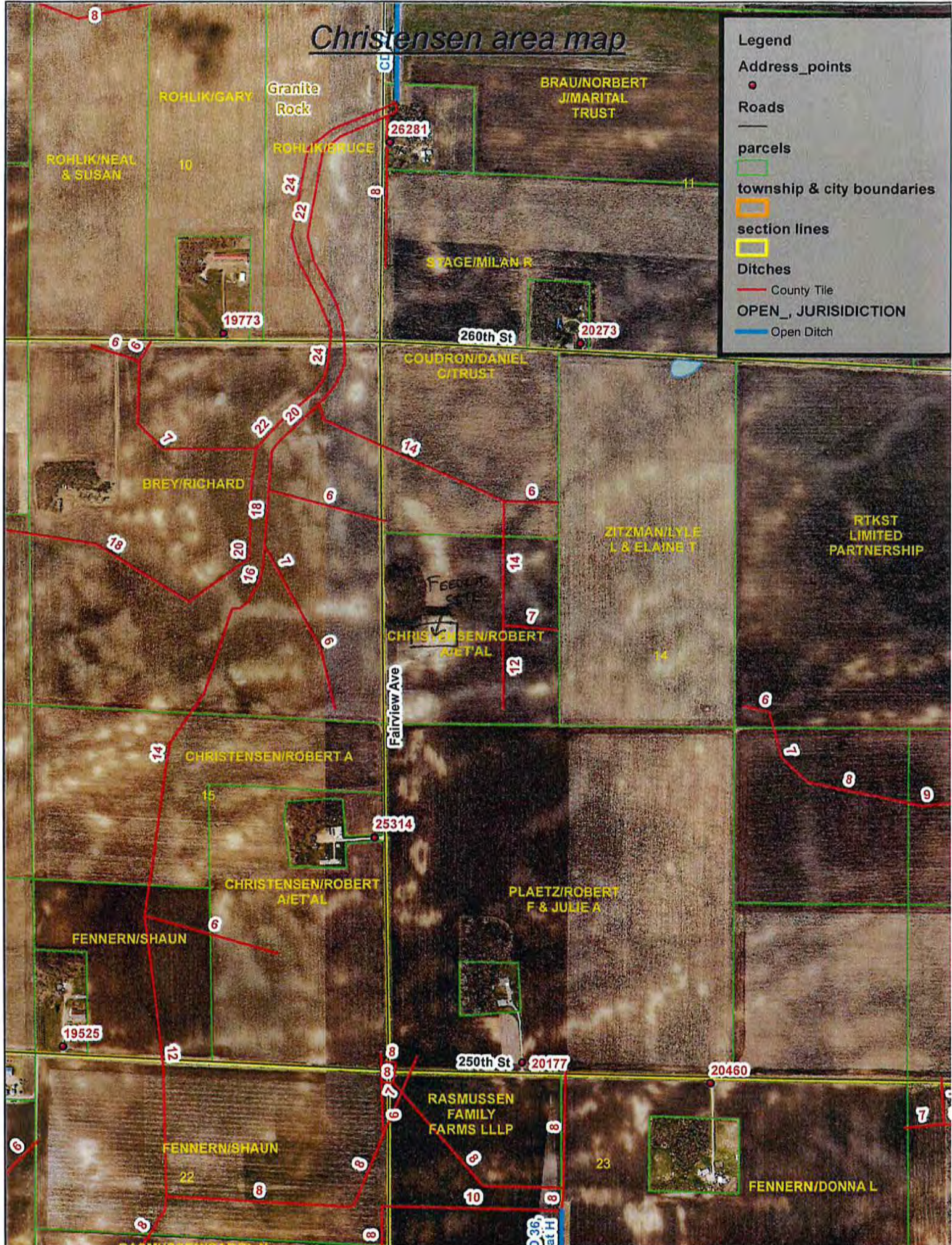

Christensen elevation map

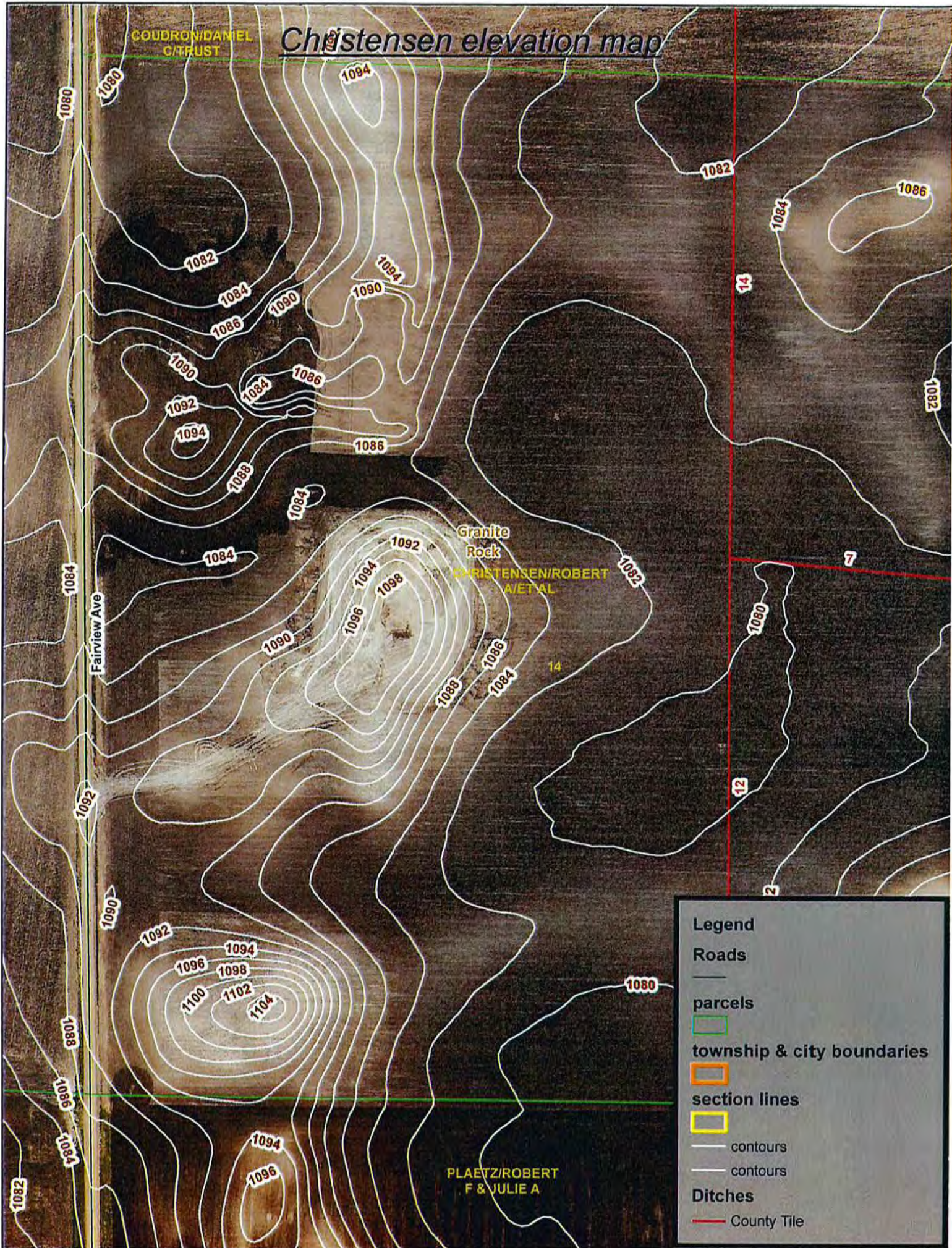

Legend

- Roads
- parcels
- township & city boundaries
- section lines
- contours
- contours
- Ditches
- County Tile

COUDRON/DANIEL
C/TRUST

Christensen soil map

999C2
Storden-Estherville-Ves
loams,
6 to 12 percent
slopes, eroded

423
Seaforth
loam

14

999B2
Ves-Estherville-Storden
complex, 3 to 6
percent slopes,
eroded

Granite
Rock
CHRISTENSEN/ROBERT
A/ET AL

7

Fairview Ave

999C2
Storden-Estherville-Ves
loams, 6
to 12
percent slopes, eroded

14

L163A
Okoboji silty
clay loam,
depressional, 0 to
1 percent slopes

12

86
Canisteo
clay
loam

954B2
Ves-Storden
loams

421B
Ves loam, 1 to 4
percent slopes

999B2
Ves-Estherville-Storden
complex, 3 to 6
percent slopes,
eroded

PLAETZ/ROBERT
F & JULIE A

Legend

Roads

parcels

township & city boundaries

section lines

Soils

Ditches

County Tile

Soils

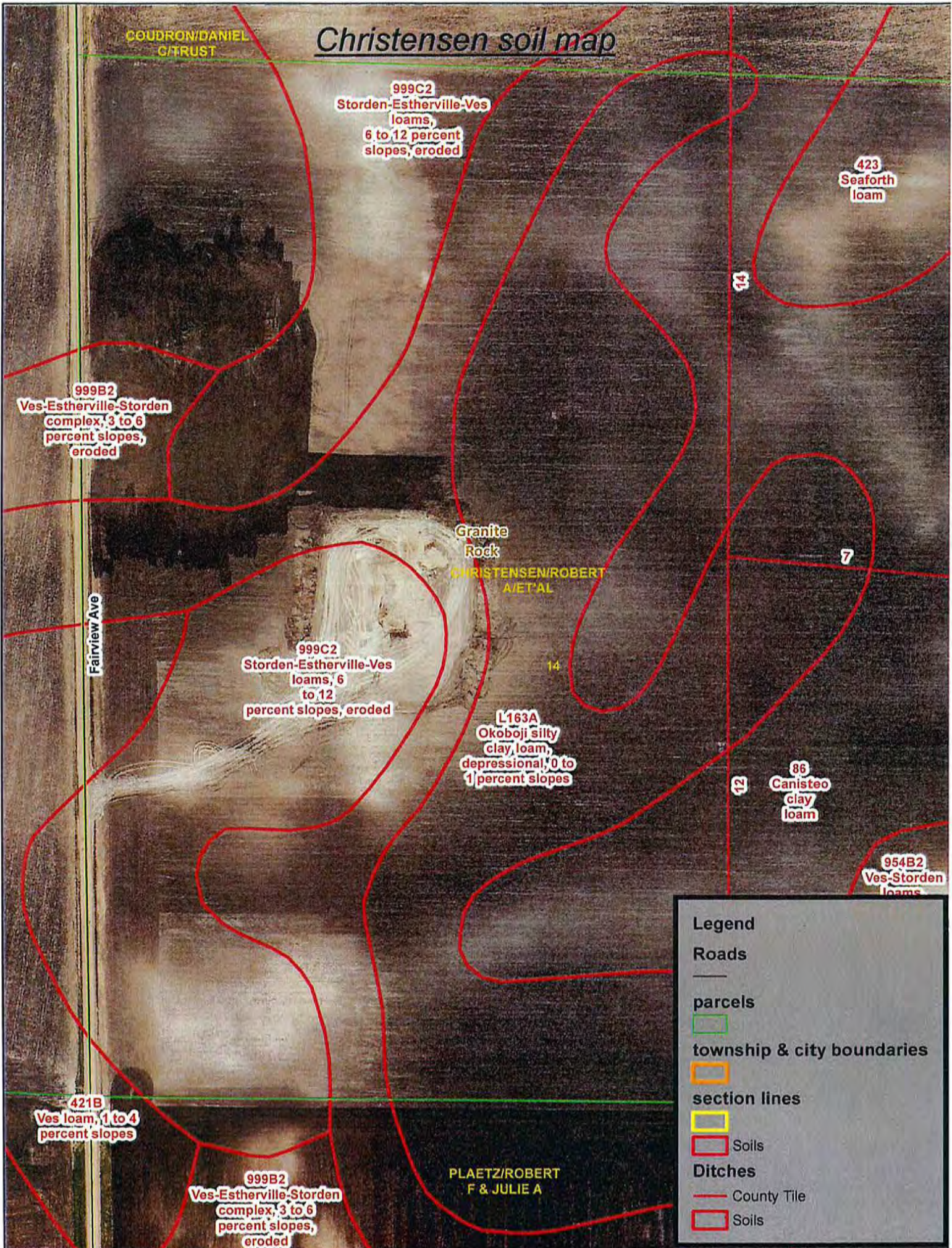







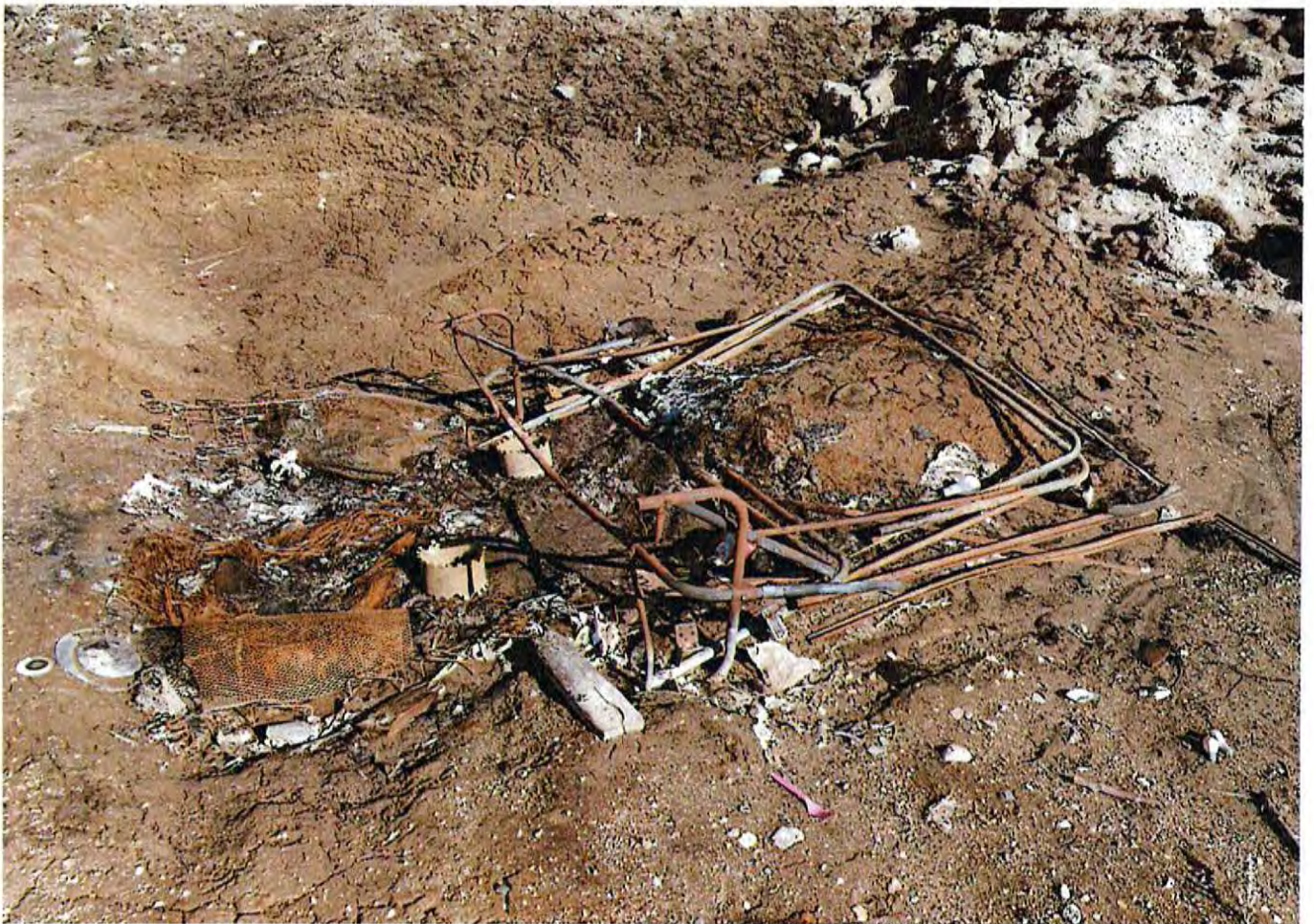

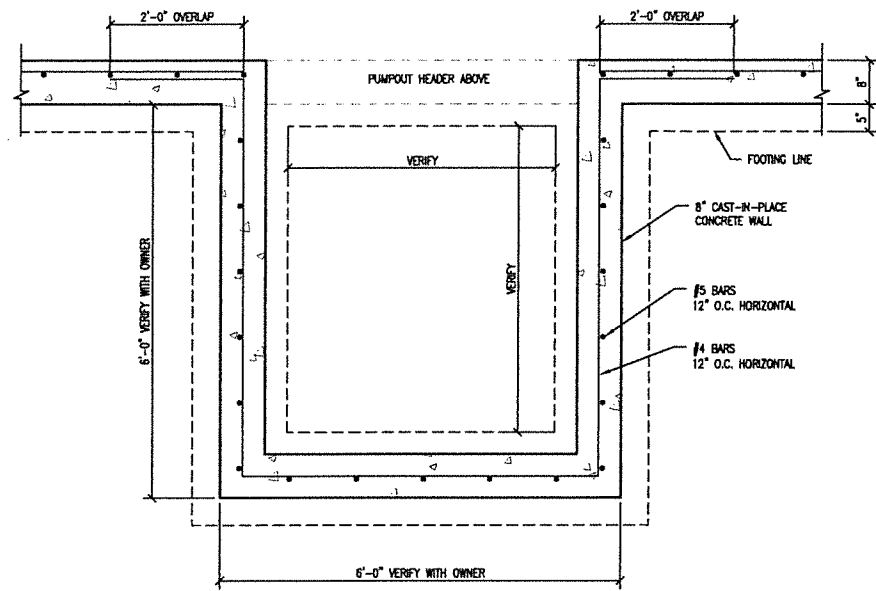

1 PUMP-OUT DETAIL
SCALE 3/4" = 1'-0"

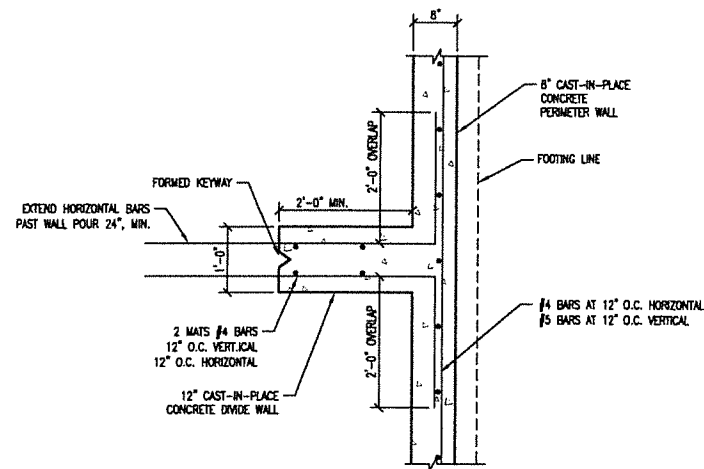

2 12" DIVIDE WALL DETAIL
SCALE 3/4" = 1'-0"

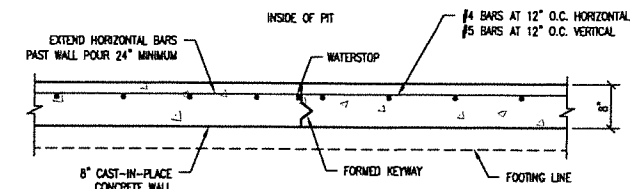

3 WALL CONSTRUCTION JOINT DETAIL
SCALE 3/4" = 1'-0"

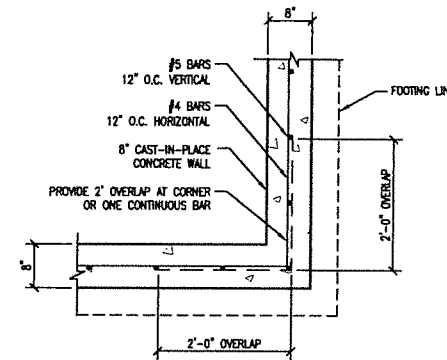

4 CORNER DETAIL
SCALE 3/4" = 1'-0"

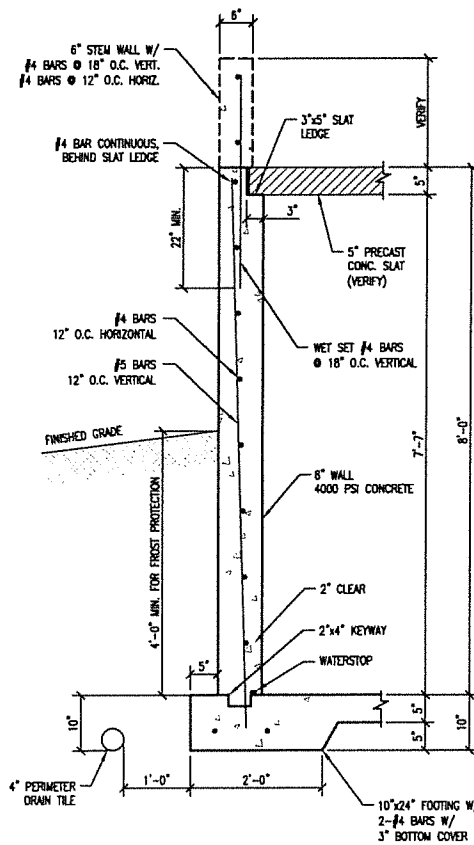

5 SIDEWALL DETAIL
SCALE 3/4" = 1'-0"

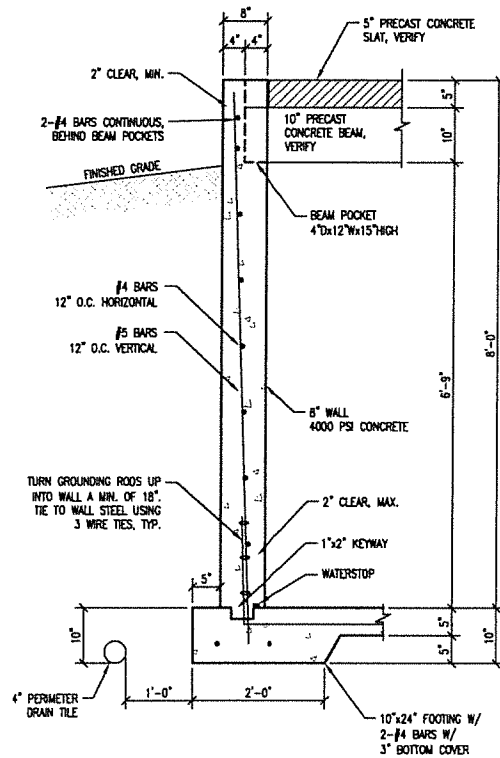

6 ENDWALL DETAIL
SCALE 3/4" = 1'-0"

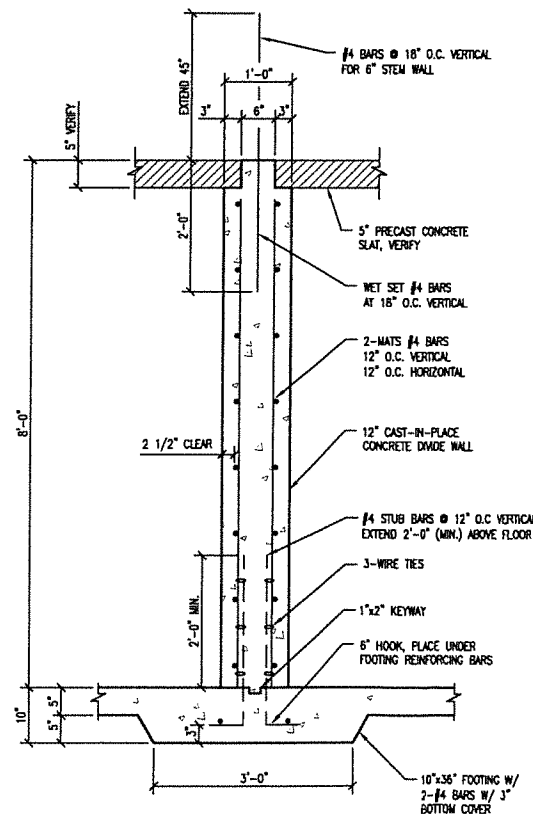

7 12" DIVIDE WALL SECTION
SCALE 3/4" = 1'-0"

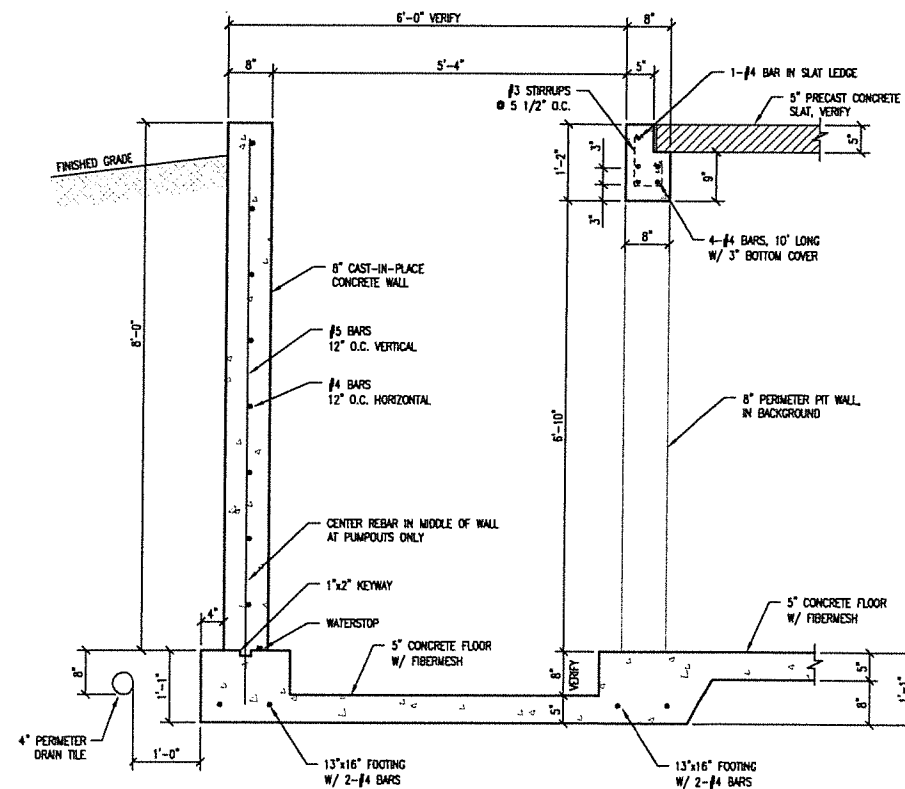

8 PUMP-OUT DETAIL
SCALE 3/4" = 1'-0"

KEY PLAN

I HEREBY CERTIFY THAT THIS PLAN, SPECIFICATION, OR REPORT WAS PREPARED BY ME OR UNDER MY DIRECT SUPERVISION AND THAT I AM A DULY LICENSED PROFESSIONAL ENGINEER UNDER THE LAWS OF THE STATE OF MINNESOTA.

JASON E. HOEHN
Jason E. Hoehn
DATE 1-13-16 LIC. NO. 40422

I HEREBY CERTIFY THAT THIS PLAN, SPECIFICATION, OR REPORT WAS PREPARED BY ME OR UNDER MY DIRECT SUPERVISION AND THAT I AM A DULY LICENSED ARCHITECT UNDER THE LAWS OF THE STATE OF MINNESOTA.

DATE _____ LIC. NO. _____
THIS DOCUMENT IS THE PROPERTY OF I+S GROUP, INC. AND MAY NOT BE USED, COPIED OR DUPLICATED WITHOUT PRIOR WRITTEN CONSENT.

PROJECT
**KYLE CHRISTENSEN
HOG BARN
102'-0" x 200'-0"**
KYLE CHRISTENSEN
19426 250TH STREET
LUCAN, MN 56255
NW 1/4 SECTION 14, T111N, R38W
GRANITE ROCK TWP., REDWOOD CO., MN

REVISION SCHEDULE		
NO	DATE	DESCRIPTION

PROJECT NO. 16-18701
FILE NAME 18701 51-53
DRAWN BY MDH
DESIGNED BY JEH
REVIEWED BY JEH
ISSUE DATE 1-13-16
CLIENT PROJECT NO.

TITLE
DETAILS

SHEET
S2

STRUCTURAL NOTES

- A. GENERAL**
- NOTES AND DETAILS ON THE STRUCTURAL DRAWINGS TAKE PRECEDENCE OVER THESE STRUCTURAL NOTES.
 - THE CONTRACTOR SHALL VERIFY ALL DIMENSIONS, ELEVATIONS, AND SITE CONDITIONS BEFORE STARTING WORK. THE ENGINEER SHALL BE NOTIFIED OF ANY CHANGES.
 - IN NO CASE SHALL DIMENSIONS BE SCALED FROM PLANS, SECTIONS, OR DETAILS ON THE STRUCTURAL DRAWINGS.
 - ALL MATERIALS AND WORKMANSHIP SHALL CONFORM TO THE REQUIREMENTS OF THE FOLLOWING CODES:
 - INTERNATIONAL BUILDING CODE (IBC)
 - MINNESOTA STATE BUILDING CODE
 - AMERICAN CONCRETE INSTITUTE (ACI)
 - CONCRETE REINFORCING STEEL INSTITUTE (CRSI) MANUAL OF STANDARD PRACTICE

- B. PERIMETER DRAIN TILE**
- THE DRAIN TILE SHALL BE HEAVY DUTY PERFORATED POLYETHYLENE TUBING, 4" DIAMETER.
 - THE TILE SHALL BE COVERED WITH A WASHED AGGREGATE, UP TO THE TOP OF FOOTING ELEVATION, AS SHOWN ON THE PLANS.
 - CONNECT THE DRAIN TILE TO AN EXISTING FARM TILE IF AVAILABLE; DISCHARGE TO SURFACE DRAINAGE; OR DRAIN TO A SUMP AND PUMP TO THE SURFACE.

- C. TEMPORARY BRACING AND BACKFILL**
- PROVIDE TEMPORARY LATERAL SUPPORT FOR ALL WALLS WHERE GRADE VARIES ON THE TWO SIDES UNTIL THE PERMANENT STRUCTURAL SUPPORT SYSTEM IS IN PLACE.
 - BACKFILL ONLY AFTER THE FLOOR SLATS OR SOLID FLOOR HAS BEEN INSTALLED.

- D. FOOTINGS AND FOUNDATION**
- SOIL BEARING DESIGN VALUE: 2500 PSF (ASSUMED) ON VIRGIN SOIL OR COMPACTED FILL FOR FOOTINGS.
 - PROTECT FOUNDATION EXCAVATIONS FROM FROST. DO NOT PLACE CONCRETE ON FROZEN GROUND.
 - FOUNDATION EXCAVATION SHALL BE KEPT FREE OF LOOSE MATERIAL AND STANDING WATER.
 - ANCHOR BOLTS SHALL BE 1/2" DIAMETER WITH 7" EMBEDMENT AND 2-3/4" PROJECTION.

- E. REINFORCED CONCRETE**
- CONCRETE SHALL HAVE A MINIMUM 28 DAY COMPRESSIVE STRENGTH OF $F'_c = 4000$ PSI.
 - WATER CEMENT RATIO SHALL BE 0.45 MAXIMUM.
 - CEMENT SHALL CONFORM TO ASTM C150 TYPE 1
 - COARSE AGGREGATE SHALL BE 3/4" MAX.
 - READY-MIX CONCRETE SHALL BE MIXED AND DELIVERED IN ACCORDANCE WITH ASTM C94.
 - SLUMP SHALL BE 6" MAXIMUM.
 - AIR CONTENT SHALL BE BETWEEN 4%-6%.
 - CONCRETE WORK SHALL CONFORM TO ALL THE REQUIREMENTS OF ACI 301.
 - ADMIXTURES MAY BE USED WITH PRIOR APPROVAL OF THE ENGINEER FOR THE PURPOSE OF INCREASING THE WORKABILITY BUT NOT TO REDUCE THE SPECIFIED MINIMUM CEMENT CONTENT. CALCIUM CHLORIDE SHALL NOT BE USED.

- F. REINFORCING STEEL**
- BAR REINFORCEMENT SHALL BE ASTM A615, GRADE 40 OR 60.
 - MINIMUM LAP SPLICE OF REINFORCING BAR, BASED ON ACI 318, CLASS B, SHALL BE AS FOLLOWS, UNLESS NOTED OTHERWISE:
 - #3 BARS.....15"
 - #4 BARS.....20"
 - #5 BARS.....24"
 - #6 BARS.....30"
 - #7 BARS.....36"
 - #8 BARS.....42"

- REINFORCING STEEL SHALL BE PROVIDED WITH THE FOLLOWING MINIMUM COVER UNLESS NOTED OTHERWISE:
 - CONCRETE PLACED AGAINST EARTH.....3"
 - FORMED CONCRETE EXPOSED TO EARTH OR WEATHER:
 - #6 BARS THROUGH #8 BARS.....2"
 - #5 BARS AND SMALLER.....1 1/2"
 - STIRRUPS & TIES.....1 1/2"
- ALL REINFORCING STEEL, ANCHOR BOLTS, DOWELS, AND INSERTS SHALL BE SECURED IN POSITION WITH WIRE POSITIONERS, OR EQUAL, BEFORE PLACING CONCRETE.
- DOWELS BETWEEN FOOTINGS AND WALLS SHALL BE THE SAME GRADE, SIZE, AND SPACING AS VERTICAL WALL REINFORCEMENT
- ALL LAP SPLICES SHALL BE TIED AT 3 LOCATIONS.

- G. TOLERANCES AND QUALITY CONTROL**
- COLUMN FINISH ELEVATIONS SHALL BE +/- 1/4" FROM DESIGN ELEVATION.
 - WALL ALIGNMENT (HORIZONTAL) SHALL DEVIATE NO MORE THAN 1/4" IN 10' NOR MORE THAN 3/4" OVER THE FULL LENGTH OF THE WALL.
 - WALL BEARING LEDGE ELEVATIONS SHALL BE +/- 1/4" FROM DESIGN ELEVATION IN 10' AND NO MORE THAN 1/2" OVER THE FULL LENGTH OF THE WALL.
 - OVERALL FOUNDATION LENGTH AND WIDTH DIMENSIONS AND DIAGONAL DIMENSIONS SHOULD BE WITHIN 1/2" OF PLAN DIMENSIONS.
 - MINOR HONEYCOMBING SHALL BE REPAIRED ON THE SAME DAY THAT THE FORMS ARE REMOVED. MAJOR HONEYCOMBING (GREATER THAN 1-1/2" DEEP) SHALL BE INSPECTED BY THE ENGINEER AND REPAIRED OR REMOVED AT HIS DIRECTION.
 - CRACKS WHICH MAY EXTEND THROUGH THE CONCRETE LINER MUST BE CLEANED AND SEALED WITH MASTERSEAL NP1 POLYURETHANE SEALANT, OR APPROVED EQUAL. LARGER CRACKS OR DEFECTS MAY NEED AN INSPECTION BY THE ENGINEER TO DETERMINE THE PROPER REPAIR.
 - TEST CYLINDERS: TAKE THREE (3) TEST CYLINDERS FOR EACH 100 CUBIC YARDS OF CONCRETE PLACED BUT NOT LESS THAN THREE (3) TEST CYLINDERS EACH DAY THAT 10 OR MORE CUBIC YARDS ARE PLACED. KEEP ONE OF EACH THREE CYLINDERS ON THE JOB SITE AND ALLOW TO FIELD CURE. DELIVER 2 OF THE 3 CYLINDERS TO A LICENSED TESTING LABORATORY TO BE CURED AND TESTED AT 7 AND 28 DAYS.

- H. ELECTRICAL GROUND**
- INSTALL REINFORCING BARS AS SHOWN ON THE DRAWING. VERIFY ELECTRICAL GROUND REQUIREMENTS WITH ELECTRICAL CONTRACTOR. NOTIFY ELECTRICAL INSPECTOR FOR INSPECTION PRIOR TO PLACING CONCRETE.

- I. COLD WEATHER CONCRETE**
- WHEN, FOR MORE THAN 3 SUCCESSIVE DAYS, THE MEAN DAILY TEMPERATURE DROPS BELOW 40 DEG. F., THE CONTRACTOR SHALL PLACE AND PROTECT THE CONCRETE IN ACCORDANCE WITH CHAPTERS 4 & 5 OF ACI 306.

- J. HOT WEATHER CONCRETE**
- WHEN IT IS LIKELY THAT TEMPERATURES BETWEEN 75 DEG. F. AND 100 DEG. F. WILL BE APPROACHED OR EXCEEDED; THAT LOW RELATIVE HUMIDITY IS PRESENT; OR WIND VELOCITY WILL EXCEED 10 MPH, THE CONTRACTOR SHALL PLACE AND PROTECT THE CONCRETE IN ACCORDANCE WITH CHAPTERS 4 & 5 OF ACI 305.

- K. WATERSTOPS**
- WATERSTOP CAN BE BENTONITE/BUTYL RUBBER, EQUAL TO WATERSTOP-RX, ULTRASTOP, SWELLSTOP OR A 4" RIBBED WITH CENTER BULB PVC WATERSTOP, EQUAL TO VINYLE-X RCB-4316. WATERSTOP SHALL BE PLACED IN ALL CONSTRUCTION JOINTS ON THE FLOOR AND IN THE PERIMETER WALLS. LOCATION AND NUMBER OF CONSTRUCTION JOINTS ARE TO BE DETERMINED BY THE CONTRACTOR.

- L. FIBERMESH**
- FIBERMESH FIBERS SHALL BE ADDED TO THE CONCRETE MIX AT A MINIMUM RATE OF 2.0 LBS PER CUBIC YARD OF CONCRETE. THE FIBERMESH SHALL BE FIBRILLATED POLYPROPYLENE OLEFIN FIBERS, 3/4" IN LENGTH.

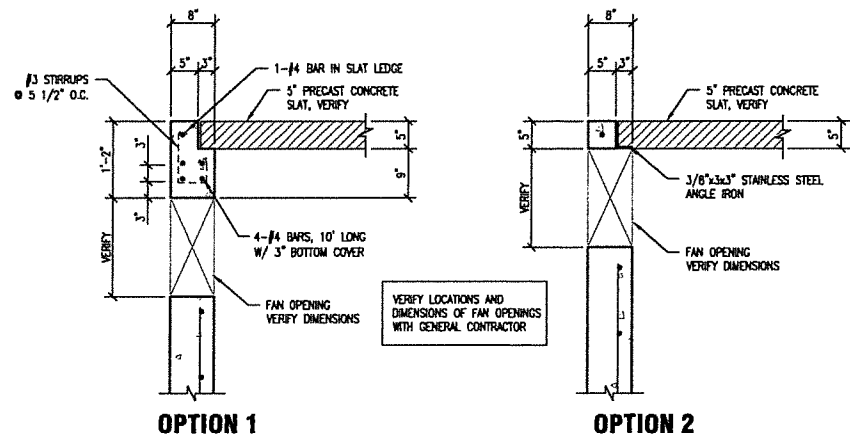

FAN OPENING DETAILS
SCALE 3/4" = 1'-0"

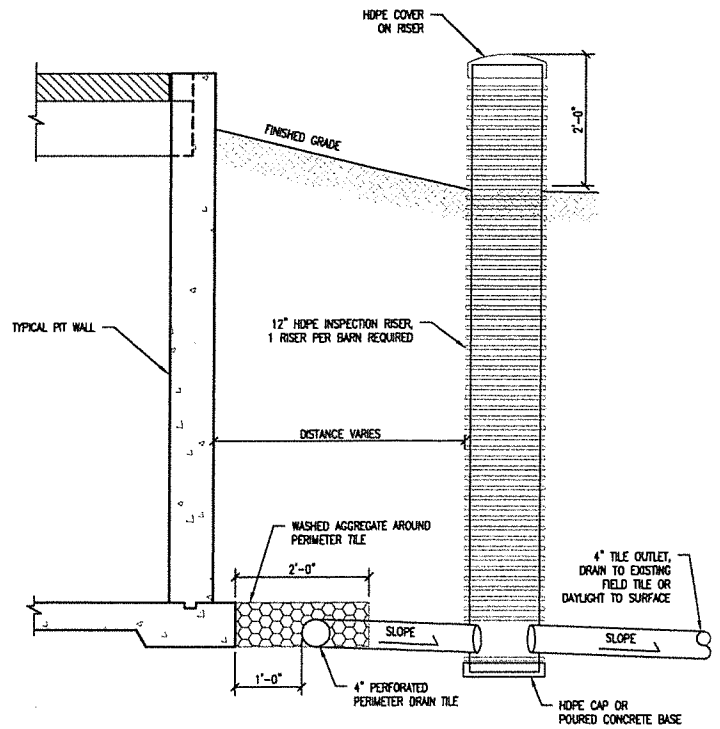

INSPECTION RISER - SECTION VIEW
SCALE 3/4" = 1'-0"

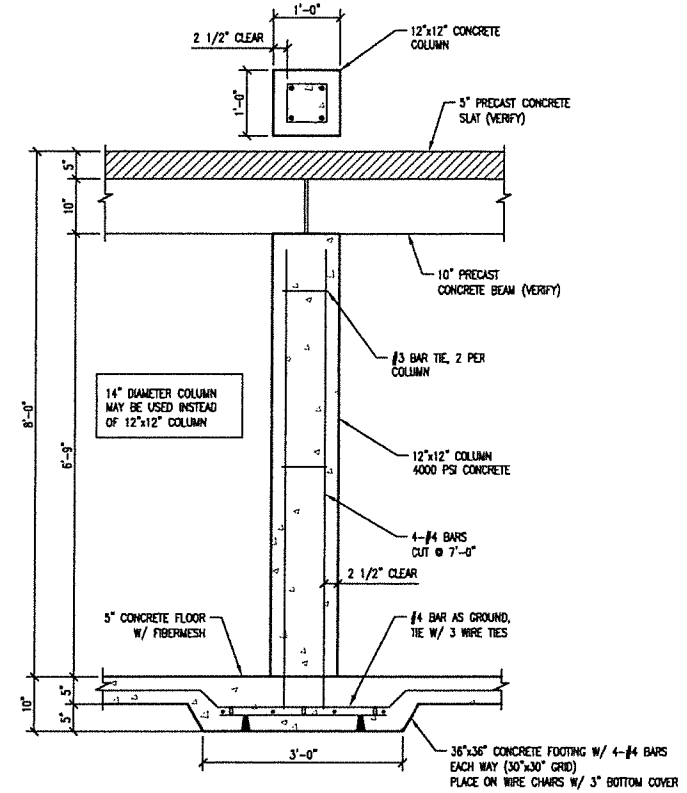

COLUMN DETAIL
SCALE 3/4" = 1'-0"

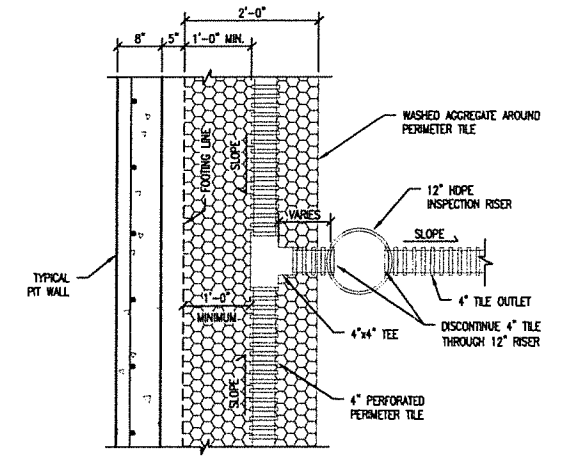

INSPECTION RISER - PLAN VIEW
SCALE 3/4" = 1'-0"



KEY PLAN
I HEREBY CERTIFY THAT THIS PLAN, SPECIFICATION, OR REPORT WAS PREPARED BY ME OR UNDER MY DIRECT SUPERVISION AND THAT I AM A DULY LICENSED PROFESSIONAL ENGINEER UNDER THE LAWS OF THE STATE OF MINNESOTA.

JASON E. HOEHN
Jason E. Hoehn
DATE: 1-13-16 LIC. NO. 40422
I HEREBY CERTIFY THAT THIS PLAN, SPECIFICATION, OR REPORT WAS PREPARED BY ME OR UNDER MY DIRECT SUPERVISION AND THAT I AM A DULY LICENSED ARCHITECT UNDER THE LAWS OF THE STATE OF MINNESOTA.

DATE: LIC. NO.
THIS DOCUMENT IS THE PROPERTY OF I+S GROUP, INC. AND MAY NOT BE USED, COPIED OR DUPLICATED WITHOUT PRIOR WRITTEN CONSENT.

PROJECT
KYLE CHRISTENSEN
HOG BARN
102'-0" x 200'-0"
KYLE CHRISTENSEN
19426 250TH STREET
LUCAN, MN 56255
NW 1/4 SECTION 14, T111N, R38W
GRANITE ROCK TWP., REDWOOD CO., MN

REVISION SCHEDULE		
NO	DATE	DESCRIPTION

PROJECT NO. 16-18701
FILE NAME 18701 S1-S3
DRAWN BY MDH
DESIGNED BY JEH
REVIEWED BY JEH
ISSUE DATE 1-13-16
CLIENT PROJECT NO.

TITLE
DETAILS & SPECIFICATIONS

SHEET
S3



Minnesota Pollution Control Agency

520 Lafayette Road North
St. Paul, MN 55155-4194

Construction Short-Form and Interim Permit Application for an Animal Feedlot or Manure Storage Area

Doc Type: Permit Application

Instructions: This form must be completed for Construction Short-Form and Interim Permits. The completed forms must be submitted to the Minnesota Pollution Control Agency (MPCA) or County Feedlot Officer in MPCA Delegated Counties.

Registration No.: _____

I. Owner's Name(s) and Address(es) (Use an asterisk (*) to indicate the primary owner for the facility if more than one owner is listed.)

Name: Kyle Christensen Address: 19426 - 250th Street City: Lucan State: MN Zip: 56255 Phone: 507-828-3285

Note: If there are more than two owners, attach to this application the names, addresses, and phone numbers of all additional owners. Under Minn. R. 7020.0300, subp. 17, the term owner includes all persons having possession, control, or title to an animal feedlot or manure storage area. All such persons must be listed on this application form. At least one owner must sign the permit application in Section XIV. If this is a Limited Liability Partnership (LLP) all partners must be listed.

- A. Have the owner(s), partner(s), or operator(s) had a criminal conviction(s) in state or federal court in the past five years involving violations of environmental rules, laws, or statutes? [] Yes [X] No
B. Do you have an agreement to transfer whole or partial ownership of the facility for which you are seeking a permit within the five-year term of the permit? [] Yes [X] No

II. Facility Name and Address (Complete if facility name/address is different than information listed above.)

Legal name of facility: Kyle Christensen Finisher Street: Fairview Ave Between 250th & 260th Streets City: Lucan State/Zip: MN 56255 Phone: 507-828-3285

III. Contact Person for Facility (This is the person MPCA contacts regarding day-to-day activities at the facility.)

Name: Street: City: State/Zip: Phone: Cell phone: E-mail: (General letters/notices may be sent by e-mail where one is indicated.)

IV. Preferred Mailing Address

Permit, reports, and other correspondence should be mailed to (check only one):

- [X] Owner address in Section I (use* if more than one) [] Facility address in Section II [] Contact person in Section III

V. Facility Location

County: Redwood

Township name: Granite Rock

Township (26 – 71 or 101 – 168)	Range (1 – 51)	Section (1 – 36)	¼ of ¼ Section: (NW, NE, SW, SE)	¼ Section (NW, NE, SW, SE)	Latitude	Longitude
T <u>111</u> N	R <u>38</u> W	14	SW	NW		

VI. Reason for Application and Previous Permit Information

A. List any existing feedlot permits: _____

B. Reason for application (check all that apply):

- | | |
|--|---|
| <input checked="" type="checkbox"/> 1. Original application for a CSF or Interim Permit. | <input type="checkbox"/> 5. Proposed reuse of an existing feedlot or manure storage area not used for five (5) years or more. |
| <input type="checkbox"/> 2. Request for reissuance of an existing CSF or Interim Permit. | <input type="checkbox"/> 6. Proposed increase in animal numbers at an existing feedlot. |
| <input type="checkbox"/> 3. Request for modification of an existing CSF or Interim Permit. | <input type="checkbox"/> 7. Proposed expansion or modification of an existing liquid or solid manure storage area. |
| <input checked="" type="checkbox"/> 4. Proposed new feedlot or manure storage area. | <input type="checkbox"/> 8. Proposed change in operation not described in 4 to 7, describe: _____ |

VII. Animal Numbers and Animal Unit (AU) Calculation

All animal numbers and animal sizes used to complete this table are to reflect the actual site conditions and should be based on the maximum weight and number of animals to be held at the facility at any one time. At no time is the number of animals at the facility allowed to exceed the capacity provided below and the type and size of animal are to remain the same.

If you have an existing facility, list the maximum number of animals held at any given time for each existing animal type in column 3 below. Next, multiply the AU Factor in column 2 by the number of animals listed in column 3 to get the Existing AU Capacity for each animal type (column 4) (do not round off numbers). Add the AU capacity numbers in column 4 for a total and enter the existing total at the bottom of the chart (do not round off numbers). If a new facility is being proposed, leave columns 3 and 4 blank.

For both new and existing facilities, in column 5 list the proposed maximum number of animals that will be held at the facility at any given time during the five year duration of the permit. Next, multiply the AU Factor in column 2 by the number of animals listed in column 5 to get the Maximum AU Capacity for each animal type (column 6) (do not round off numbers). Note: the number in column 5 should include existing animals plus or minus any expansion or reduction in each animal type. Add the AU capacity numbers in column 6 for the Final AU Total and enter the total at the bottom of column 6 (do not round off numbers).

1. Animal type	2. Animal Unit factor	3. Existing number of animals (leave blank if new site)	4. Existing AU capacity = column 2 x column 3	5. Maximum number of animals (for new or after expansion)	6. Maximum AU capacity = column 2 x column 5
A. Dairy cattle					
Mature cow (milked or dry) over 1,000 pounds	1.4				
Mature cow (milked or dry) under 1,000 pounds	1.0				
Heifer	0.7				
Calf	0.2				
B. Veal					
Veal	0.2				
C. Beef cattle					
Slaughter steer/heifer, stock cow, or bull	1.0				
Feeder cattle (stocker or backgrounding), heifer	0.7				
Cow and calf pair	1.2				
Calf (weaned)	0.2				
D. Swine					
Over 300 pounds	0.4				
Between 55 and 300 pounds	0.3			2480	744
Under 55 pounds	0.05				
E. Horses					
Horse	1.0				
F. Sheep					
Sheep or Lamb	0.1				
G. Chickens with a LIQUID manure system					
Layer Hens or Broilers	0.033				
H. Chickens with a DRY manure system					
Broilers over 5 pounds	0.005				
Broilers under 5 pounds	0.003				
Layer Hens over 5 pounds	0.005				
Layer Hens under 5 pounds	0.003				
I. Turkeys					
Over 5 pounds	0.018				
Under 5 pounds	0.005				
J. Ducks					
Duck (with a liquid manure handling system)	0.01				
Duck (with a dry manure handling system)	0.01				
K. Animals not listed in A to J (AU factor in column 2 = average weight of the animal type divided by 1,000 pounds)					
Animal type 1: _____	1: _____	1: _____	1: _____	1: _____	1: _____
Animal type 2: _____	2: _____	2: _____	2: _____	2: _____	2: _____
Total animal unit capacity			Existing AU Total		Final AU Total
Add all numbers in column 4 for Existing AU total					
Add all numbers in column 6 for Final AU total					744

VIII. Buildings, Lots, Manure Handling, Feed, and Dead Animal Storage Areas

Complete the table below for your animal holding, manure storage, feed/silage storage, and dead animal disposal areas. A list of common facility types is provided to choose from or describe it in your own terms. If you have more than six animal holding, manure storage, feed/silage storage areas, and dead animal disposal areas on your site, please attach a separate sheet that includes the information requested below for each additional facility. Each of the facilities listed below should correspond to those provided on the sketch required in Section XI on page 6 of this application.

A. Facility number	# 1	# 2	# 3	# 4	# 5	# 6
Write "Existing", "New", or "Eliminating"	New	New				
B. Types of Animal Confinement Areas <i>Write approximate dimensions in feet in the space below (width x length)</i>						
Total confinement barn	102' x 200'					
Partial confinement barn						
Open lot with runoff controls						
Open lot without runoff controls						
Pasture access	<input type="checkbox"/> Yes <input checked="" type="checkbox"/> No	<input type="checkbox"/> Yes <input type="checkbox"/> No	<input type="checkbox"/> Yes <input type="checkbox"/> No	<input type="checkbox"/> Yes <input type="checkbox"/> No	<input type="checkbox"/> Yes <input type="checkbox"/> No	<input type="checkbox"/> Yes <input type="checkbox"/> No
C. Facility floor type <i>Place "X" in box that best describes component floor type</i>						
Slats over manure storage	X					
Concrete slab						
Earthen or dirt						
Other (describe):						
D. Liquid storage areas <i>Write approximate top dimensions in feet in the space below (width x length x depth)</i>						
Earthen or soil lined						
Poured reinforced concrete	102' x 200' x 8'					
Composite lined						
Above-ground concrete tank						
Fiberglass-lined steel tank						
Concrete block or stave pit						
Milk center wastewater storage						
Feed/silage runoff storage						
Other (describe - include other process wastewater storage):						
E. Handling areas for solid manure, feed and dead animals <i>Note approximate dimensions in feet (width x length x depth)</i>						
Stacking slab						
Stockpile						
Manure pack on lot or floor						
Feed storage areas - (describe if covered or uncovered)						
Dead animal treatment		10' x 10'				
Other (describe):						
F. Animal Numbers <i>Note: these animal numbers should total the same as proposed animal numbers listed on page 2</i>						
Mature dairy cows (over 1,000 lbs)						
Mature dairy cows (under 1,000 lbs)						
Dairy heifers						
Dairy calves						
Veal						
Slaughter steer/heifer, stock cow or bull						
Feeder cattle-stocker/background/heifer						
Cow and calf pair						
Beef calves (weaned)						
Swine over 300 lbs						
Swine between 55 and 300 lbs	2480					
Swine under 55 lbs						
Horses						
Sheep or lamb						
All chickens w/liquid manure system						
Broiler chickens over 5 lbs - dry system						
Broiler chickens under 5 lbs - dry system						
Laying hens over 5 lbs - dry system						
Laying hens under 5 lbs - dry system						
Turkeys - over 5 lbs						
Turkeys - under 5 lbs						
Ducks						
Others (list types):						
1.						
2.						

IX. Soils, Location, Surface Water, and Ground Water Features

A. Soils.

List the soil type or texture and depth to saturated soils at the facility as identified in the U.S. Department of Agriculture (USDA) Soil Survey Manual for your county or from a site-specific soil investigation. Owners submitting manure storage area plans and specifications, as required in Section XIII, item D., of this application, with a completed soils investigation should write "see enclosed" if included.

1. Soil type(s) or texture(s): See Engineering Plans
2. Depth to seasonal high water table or saturated soils: Se Engineering Plans

B. Sensitive areas.

The following information is needed to determine compliance with location restrictions. Questions 1 and 2 relate to restrictions in Minn. R. chapter 7020. Questions 3 to 7 are necessary to evaluate mandatory Environmental Assessment Worksheet (EAW) requirements under Minn. R. 4410.4300, for new facilities of 500 AU or more and existing facilities expanding by 500 AU or more. Please answer if the facility (existing and proposed) is located wholly or partially in any of the following sensitive locations:

1. Shoreland:
 - a. Are there any rivers or streams within 300 feet of the feedlot? Yes No
 - b. Are there any lakes or ponds with designated shoreland within 1,000 feet of the feedlot? Yes No

If you answered yes to (a) or (b), list the names of these water bodies and the approximate distance (in feet) to the feedlot.

Name: _____ Approximate distance: _____
Name: _____ Approximate distance: _____
2. A delineated flood plain? Yes No
3. A state or federally designated wild and scenic river district? Yes No
If yes, name: _____
4. The Minnesota River Project Riverbend Area? Yes No
5. The Mississippi Headwaters Area? Yes No
6. A drinking water supply management area delineated under chapter 4720 where the aquifer is identified in the wellhead protection plan as vulnerable to contamination? Yes No
7. Within 1,000 feet of a known sinkhole, cave, resurgent spring, disappearing spring, Karst window, blind valley, or dry valley? Yes No
If yes to question 7, is the facility within 300 feet of a sinkhole? Yes No

C. Wells.

The following information is needed to determine compliance with Minnesota Department of Health Well Codes and Minn. R. 7020.2005.

1. Is the facility located within 100 feet of a private well? Yes No
2. Is facility located within 1,000 feet of the following types of wells: a community water supply well, a well serving a public school as defined under Minn. Stat. §120A.05, a private school, excluding home school sites, or a licensed child care center where the well is vulnerable according to Minn. R. 4720.5550, subp. 2? Yes No
3. What is the shortest distance (in feet) from an animal holding area to a well?
Building/lot number from page 3: 1 Approximate distance: Approx 110'
4. What is the shortest distance (in feet) from a manure storage area to a well?
Structure/area number from page 3: 1 Approximate distance: Approx 110'

D. Surface tile intakes.

Are any surface tile intakes within 1,000 feet of animal holding, manure storage areas, or any other part of the production facility? Yes No

Building/lot number from page 3: 1 Approximate distance: Approx 400"

X. Manure Management

The type of manure management plan required for your facility depends on whether you transfer ownership of your manure to another person. Begin with part X.A. and follow the instructions to determine if you transfer ownership and which type of manure management plan you need to complete.

A. Transferred manure.

1. Answer questions 1.a. and 1.b. below to see if you (the feedlot owner/operator) transfer ownership of any of your manure.

a. Is all manure from your feedlot applied onto land that is owned, leased, or rented by yourself? Yes No

If you answer "Yes" then you do not transfer ownership of your manure and you can move on to Section X.B.

If you answer "No", go to the next question (1.b.).

- b. For **all** manure application sites not owned, leased or rented by the feedlot owner/operator, have you (the feedlot owner/operator) or employees working under your direction been given control of the field and nutrient planning decisions, including planning for nutrient rates, timing and methods? Yes No

For fields where the answer is "Yes," ownership of manure is **not** transferred and you can move on to item B (non-transferred ownership).

For fields where the answer is "No," manure ownership is considered to be transferred and you **must** complete item 2, below.

2. If all or part of the ownership of your manure is transferred, complete items a. through c., below.

a. Approximately how much of your manure (in tons or gallons) has transferred ownership?

- b. For all manure where ownership is transferred, complete the manure management plan requirements as described in the MPCA guidelines "Manure Management Plan Requirements when Ownership of Manure is Transferred", which can be found at the MPCA website at: <http://www.pca.state.mn.us/hot/feedlot-management.html>. For an Interim Permit submit the manure management plan with this permit application. For a Construction Short Form permit, be prepared to submit the plan if requested by your County Feedlot Officer or MPCA staff person.

- c. Where a land application agreement(s) exists for application of transferred manure to neighboring land how many acres are available under the access agreement(s)?

Are the signed land application agreements enclosed?
(see example agreement form at the MPCA website at:
<http://www.pca.state.mn.us/publications/feedlots-landappagreementform.pdf>)

Yes No

B. Non-transferred manure.

For all other manure (where ownership of manure is **not** transferred), complete items 1 and 2, below.

1. List the number of acres available for spreading non-transferred manure:

Acres owned: 285 Acres rented/leased: 400 390

Other acres where the feedlot owner/operator controls field and nutrient planning decisions: _____

Are signed land application agreements enclosed for these acres?

(see example agreement form at the MPCA website at:

<http://www.pca.state.mn.us/publications/feedlots-landappagreementform.pdf>)

Yes No

2. Prepare a manure management plan that includes the required items in the MPCA guidelines "Manure Management Plan Requirements when Ownership of Manure is Transferred", which can be found at the MPCA website at: <http://www.pca.state.mn.us/hot/feedlot-management.html>.

XI. Site Sketch

Use this page to draw a sketch of the existing facilities and any proposed facilities. The sketch must show the location of buildings, manure storage areas, silage and feed storage areas, milking center wastewater storage or treatment areas, and runoff control structures. The sketch must also show all tile inlets, wells, rivers or lakes, sinkholes, and water courses within 1,000 feet of the facility. Show the approximate path that water running off outside lots follows. Label barns, open lots, and manure storage areas on this sketch with the same number that each structure is listed under Part VIII. on page 3 of this application (i.e., Barn #1 on page 3 should be labeled #1 on the sketch).

See attached map

Section 14
Granite Rock township

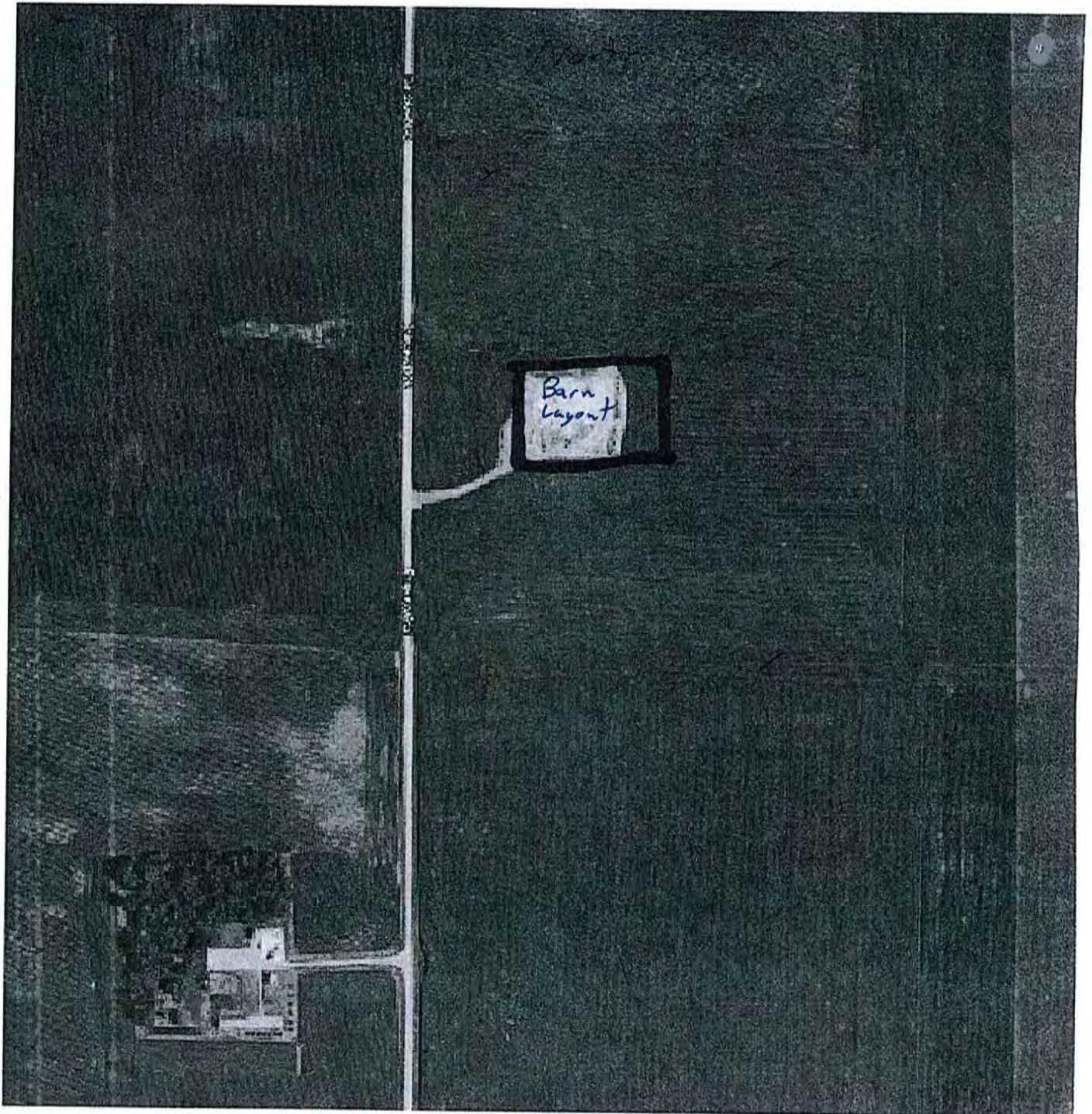

XII. Required Notifications for Permit Application Process

The notifications under items A through C are required to be done during the permit application process. Additional notices are required to be made by the feedlot owner/operator in accordance with 1) Minn. R. 7020.2002 during removal of manure; 2) Minn. R. 7020.2100, subp. 5, for construction of a liquid manure storage system; and 3) Minn. R. 7020.2125, subp. 4.E., for construction of a permanent manure stockpile area.

A. All facilities: Notice to county, township, and city authorities.

An owner of an animal feedlot or manure storage area (facility) proposing to construct a new or expand an existing facility of any AU capacity shall complete the information listed below and submit a copy to all local units of government that may have zoning authority over the project (e.g., if the project is located in a township, submit the form to the township **and** to the county).

Name of owner(s) or legal name of facility: Kyle Christensen
(Please Print)

Location: Redwood Granite Rock 14 NW SW
County Township Section ¼ Sec. ¼ of ¼

Type (species) of livestock: Swine Total AUs: 744

Type(s) of confinement buildings, lots, and animal holding areas: Total Confinement Barns

Type(s) of manure storage areas: Engineered Below Barn Concrete Storage Pits

List the local authorities that have been notified: County: Redwood Township and/or city: Granite Rock

B. 500 or more AU: Notice to residents and property owners within 5,000 feet of a proposed project.

- Notice Methods.** An owner of an animal feedlot or manure storage area that is **proposing to construct a new or expand an existing facility** to house 500 AU or more, or store the manure generated by 500 AU or more (after construction or expansion), shall not less than 20 business days before the anticipated issuance date of the permit, provide notice to each resident and each owner of real property within 5,000 feet of the perimeter of the proposed facility. This notice must be completed in one of the following methods:
 - Newspaper Notice.** Publish in a newspaper of general circulation within the affected area a notification containing the information listed in item A., above.
 - Written Notice:** Send a written notice to each resident and owner of real property containing the information listed in item A. above. This notice may be delivered by first-class mail or in person.
 - Conditional Use Permit Notice:** Provide equal or greater notification than that required in item A. above as part of obtaining a county Conditional Use Permit.
- Verification of Notice.** I have attached the information that documents that the necessary steps have been taken to complete the notice method not less than 20 days before I expect my permit to be issued. This information consists of one or more of the following forms of notice (check all that apply):
 - A list of all parties, with their location, that were personally visited with a date and signature from each party.
 - A list of all parties, with their location, that were personally visited with certification signed by a notary public indicating in detail what was discussed.
 - A list of all parties, with their location, that were notified by certified mail and copies of all signed certified mail return receipts.
 - An affidavit of publication from the newspaper used to provide this notification.

C. Public meeting for facilities with less than 1,000 AU.

If your facility:

- Will have a capacity of less than 1,000 AU.
- Is constructing a new facility or expanding an existing facility.

Has a public meeting been held, or will a public meeting be held, where citizens will be provided an opportunity to give input regarding your facility?

Yes No

If "Yes", provide the date (mm/dd/yyyy): _____

XIII. Required Enclosures (Permit applications submitted without all required enclosures are **incomplete**.)

- A. Site Sketch** required under Section XI.
- B. Aerial Photograph** of the land within 1,000 feet of the facility. The aerial photograph must show the location of buildings, manure storage areas, silage and feed storage areas, dead animal storage areas, milking center storage or treatment areas, and runoff control structures.
- C. Manure Management Plan** including the information listed in Section X (interim permit applications only; submit the manure management plan with construction short form applications when requested by the County Feedlot Officer or MPCA staff person).
- D. Plans and Specifications for construction** of any liquid manure storage area. If construction, expansion, or modification of a liquid manure storage structure is proposed as part of this permit application, plans and specifications that meet the requirements in Minn. R. 7020.2100 are to be developed and submitted with this application. If construction, expansion, or modification of a permanent manure stockpile site is proposed as part of this permit application, and the stockpile site requires a liquid manure storage area for runoff containment, the owner must include plans and specifications required in Minn. R. 7020.2100.
- E. Notifications** required under Section XII.

XIV. Applicant's Agreement and Certification

I, the undersigned applicant(s), in accordance with Minn. R. chapter 7020 for the control of pollution from animal feedlots and manure storage areas and the Code of Federal Regulations 40 § 122, hereby apply to the MPCA for a permit to construct, expand, and/or operate an animal feedlot or manure storage area under a construction short form and/or an interim permit. I certify that, in accordance with Minn. R. 7020.0505, subp. 4, item E, and 40 CFR 122.21, I will submit additional information relating to the facility design, construction, or operation as requested by the MPCA to evaluate compliance with applicable federal and state laws and rules.

I hereby certify that the design, construction, and/or operation of the facility described in this permit application will be in accordance with the plans, specifications, reports, and related communications approved by the MPCA or delegated county feedlot pollution control officer and on file in its office; and in accordance with the conditions that have been or may be imposed in the permit or any applicable regulations or standards of the MPCA. I further certify that the design, construction, and operation of the facility will be in full compliance with the MPCA feedlot rules, Minn. R. chapter 7020.

I also certify under penalty of law that this document and all attachments were prepared under my direction or supervision in accordance with a system designed to assure that qualified personnel properly gather and evaluate the information submitted. Based on my inquiry of the person or persons who manage the system, or those persons directly responsible for gathering the information, the information submitted is, to the best of my knowledge and belief, true, accurate, and complete. I am aware that there are significant penalties for submitting false information, including the possibility of fine and imprisonment for knowing violations.

Applicant's signature

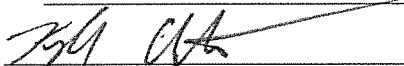
Print name: Kyle Christensen Print official title: Owner
Office phone: _____ Cell phone: 507-828-3285
Signature:  Date (mm/dd/yyyy): 3-11-16

Manure Storage, Handling, and Testing Information

Facility Name: Christensen Finisher Granite Rock 14 NPDES or SDS Permit? No Permit Number: _____
 Owner/Operator Name: Kyle Christensen Date Last Revised: 2/23/2016 Registration Number: _____

Version 6.21 Last Updated: 8/19/15

Manure Sources	Manure Source #1	Manure Source #2	Manure Source #3	Manure Source #4
Description of Manure Source <small>Group sources with similar nutrient content if they have identical animal type, water usage, feed rations, and manure storage</small>	Finishing Pigs			
Livestock Information				
Predominate Animal Type <small>(Contributing to Manure Source)</small>	Swine- Wean/Finish (wet/dry feed)			
Average Animal Weight	140 lbs	lbs	lbs	lbs
Animal Number	2,480	days/yr	days/yr	days/yr
Length of Time Livestock Spend In Facility	355 days/yr			
Additional Animal Type <small>(Contributing to Manure Source)</small>				
Average Animal Weight	lbs	lbs	lbs	lbs
Animal Number	days/yr	days/yr	days/yr	days/yr
Length of Time Livestock Spend In Facility				
Storage Information				
Storage Type	Underfloor Concrete Pit			
Capacity	955,000 gals			
Storage Length	13 months			
Application Methods				
Commercial Applicator Name (if Used)				
Spreader Type	Liquid Tanker			
How Volume/Tonnage Determined per Load	Commercial Applicator			
How Application Rate is Calibrated	Commercial Applicator			
Manure Analysis				
Sampling Frequency	Every Year			
Sampling Methods	Well Agitated Composite			
Date Last Analyzed				
Basis for N, P, & K Values Below	Average of Previous			
Total N - (do not enter lab estimated availability)	54 lbs/1000 gal			
Total P ₂ O ₅ - (do not enter lab estimated availability)	25 lbs/1000 gal			
Total K ₂ O - (do not enter lab estimated availability)	38 lbs/1000 gal			
Annual Nutrients Generated				
Total Manure Produced per Year (Estimated)	638,230 gals			
Total Manure Produced per Year (Actual)	651,000 gals			
Annual N Produced	35,154 lbs	lbs	lbs	lbs
Annual P ₂ O ₅ Produced	16,275 lbs	lbs	lbs	lbs
Annual K ₂ O Produced	24,738 lbs	lbs	lbs	lbs

Average Book Values	Average Book Values	Average Book Values
N	N	N
P ₂ O ₅	P ₂ O ₅	P ₂ O ₅
K ₂ O	K ₂ O	K ₂ O

Sensitive Features Management Worksheet

This worksheet identifies all allowable techniques that can be used to provide protection to sensitive features as required in Minnesota Rules and/or permit conditions. One of the following measures will be employed for the applicable sensitive feature. Any of the identified practices are acceptable.

Tile Intakes

- I will utilize one of the Options A - D on fields with this feature, or utilize Option E that provides equal or greater water quality protection than Options A - D
- Option A - Inject or incorporate within 24 hours and prior to rainfall within 300 ft, observe a 25 ft non-manured setback, and avoid long term soil P build-up
- Option B - Inject or incorporate within 24 hours and prior to rainfall within 300 ft, observe a 25 ft non-manured setback, and avoid long term soil P build-up
- Option C - 35 ft grassed buffer
- Option D - 100 ft setback with at least 16.5 ft as grassed buffer
- Option E - Other:

Drainage Ditches

NO FIELDS WITH THIS FEATURE

- Option A - Inject or incorporate within 24 hours and prior to rainfall within 300 ft, observe a 25 ft non-manured setback, and avoid long term soil P build-up
- Option B - 50 ft wide grassed buffer
- Option C - 100 ft setback with at least 16.5 ft as grassed buffer
- Option D - Protective Berm (prohibits runoff from entering the ditch)
- Option E - Other:

Lakes, Rivers, and Streams

NO FIELDS WITH THIS FEATURE

- Option A - Inject or incorporate within 24 hours and prior to rainfall within 300 ft, observe a 25 ft non-manured setback, and avoid long term soil P build-up
- Option B - 100 ft wide grassed buffer
- Option C - 100 ft setback with at least 16.5 ft as grassed buffer
- Option D - Other:

Intermittent Streams and/or Public Waters Wetlands (over 10 acres)

NO FIELDS WITH THIS FEATURE

- Option A - Inject or incorporate within 24 hours and prior to rainfall within 300 ft, observe a 25 ft non-manured setback, and avoid long term soil P build-up
- Option B - 50 ft wide grassed buffer
- Option C - 100 ft setback with at least 16.5 ft as grassed buffer
- Option D - Other:

Wells, Mines, or Quarry

NO FIELDS WITH THIS FEATURE

- Option A - 50 ft setback - minimum (100 ft if NPDES permitted)

Sinkholes

NO FIELDS WITH THIS FEATURE

- Option A - Inject or incorporate within 24 hours and prior to rainfall upslope and within 300 ft and observe a 50 ft non-manured setback (100 ft non-manured setback for NPDES)
- Option B - Berm that prevents runoff from entering the sinkhole

This worksheet identifies all allowable techniques that can be used to provide protection to sensitive features as required in Minnesota Rules and/or permit conditions. One of the following measures will be employed for the applicable sensitive feature. Any of the identified practices are acceptable.

Other Conduits to Water

NO FIELDS WITH THIS FEATURE

- Option A - Inject or incorporate within 24 hours and prior to rainfall within 300 ft, observe a 25 ft non-manured setback, and avoid long term soil P build-up
- Option B - 50 ft wide grassed buffer
- Option C - 100 ft setback with at least 16.5 ft as grassed buffer
- Option D - Protective Berm (prohibits runoff from entering the waters)
- Option E - Other: _____

Early Fall Land Application

NOT APPLICABLE TO THIS OPERATION

This only applies to NPDES or SDS permitted facilities that have indicated manure will be applied in early fall

- Option A - Fall Application onto fields that are dominated by coarse-textured soils shall be delayed until soil temperatures in the upper six (6) inches, are less than 50 degrees Fahrenheit, unless otherwise first approved by the MPCA.

Application of Manure During the Summer Months (June, July, and August)

NOT APPLICABLE TO THIS OPERATION

- Option A - A cover crop will be planted on all fields that receive manure applications during June, July, and August

Soil Erosion Conservation Measures

NOT APPLICABLE TO THIS OPERATION

Required for any fields used for winter application and for all fields at NPDES permitted sites.

- Option A - Establish grassed waterways
- Option B - Contour stripcropping
- Option C - No-Till cropping
- Option D - Terracing
- Option E - Use rotations that include other than row crops (alfalfa, grass, etc)
- Option F - Chisel or disk tillage with residue
- Option G - Meet tolerable soil erosion rates ("T") as defined by NRCS
- Option H - Field edge buffers
- Option I - Contour buffer strip
- Option J - Sediment control basin
- Option K - Plant a cover crop on bare ground
- Option L - Other: _____

Land Application of Manure Planning Worksheet (Fields 1 - 25)



Minnesota Pollution Control Agency

Name of Facility Where Manure is Generated: Christensen Finisher Granite Rock 14

Registration/Permit Number: _____

Is a Licensed Commercial Animal Waste Technician Used? No Name: _____

License Number: _____

Manure Source Summary			
Source 1: Finishing Pigs	N: 54	P: 25	K: 38
Source 2:	N: _____	P: _____	K: _____
Source 3:	N: _____	P: _____	K: _____
Source 4:	N: _____	P: _____	K: _____
	Source 5:	Source 6:	Source 7:
	Source 8:	Source 9:	Source 10:

Field ID	Acres After Setbacks	Soil Test Phosphorus (P) Field Average (ppm)	Crops Grown Summary		Nutrients Needed From Manure Application				Manure Application Information			Nitrogen (lb N/ac)	Phosphorus (lb P ₂ O ₅ /ac)	Potassium (lb K ₂ O/ac)				
			Crop Grown to Utilize the Nutrients Applied	Crop Most Recently Harvested	Nitrogen Needs	Nitrogen (Removal)	Phosphorus (Removal)	Potassium (Removal)	Manure Source (1-8)	Method of Application and Incorporation	Acres Receiving Manure (from the chosen source)				Max Nitrogen Based Application Rate (gals or tons per acre)	N from Manure (Available this year)	Excess Available N (negative for deficiency)	P from Manure (Available this year)
Kyles GR 22	38	3 Olsen	Soybeans	Corn	---	193	45	55	1			---	140	0	45	---	111	-55
Haag 40 GR 14 SW of NW	38		Corn	Soybeans	140	---	65	36	1			3,241	140	0	65	0	111	75
JR GR 25 SE NW & N of SW	94		Corn	Soybeans	140	---	65	36	1			3,241	140	0	65	0	111	75
Johnson E GR 25 SE	78		Soybeans	Corn	---	193	45	55				---	---	0	---	---	---	-55
Johnson W GR 25 SE	78		Corn	Soybeans	140	---	65	36	1			3,241	140	0	65	0	111	75
Haag GR 15 SE	113	8 Olsen	Soybeans	Corn	---	193	45	55				---	---	0	---	---	---	-55
Lydia E GR 26	50	4 Olsen	Soybeans	Wheat	---	665	156	190				---	---	0	---	---	---	-190
Lydia M GR 26	50	7 Olsen	Wheat	Corn	85	---	32	50				---	---	-85	---	---	---	-50
Lydia W GR 26	50		Corn	Soybeans	140	---	65	36				---	---	-140	---	---	---	-36
Shaun F GR 22 N of NE	81		Soybeans	Corn	---	193	45	55				---	---	0	---	---	---	-55

MMP NOTES

This worksheet will allow entry of notes related to the MMP. This can be used to explain a part of the plan, notes regarding fertilizer/pesticide applications, or any other item that is applicable.

Simply start typing in any of the cells below, the cell will auto adjust to accommodate the length of the text entered.

Misc. Notes for all Fields (Enter applicable notes for specific field ID's below)	The fields lacking Soil Test info will be sampled in the Fall of 2016. An updated MMP will be provided when the data is available.
Kyles GR 22	
Haag 40 GR 14 SW of NW	
JR GR 25 SE NW & N of SW	
Johnson E GR 25 SE	
Johnson W GR 25 SE	
Haag GR 15 SE	
Lydia E GR 26	
Lydia M GR 26	
Lydia W GR 26	
Shaun F GR 22 N of NE	

Animal Mortality Management Worksheet



Minnesota Pollution Control Agency

Indicate with a check mark the anticipated method(s) of dead animal disposal.

Rendering

Carcasses at the pick-up point will comply with the following:

- Kept in an animal-proof, enclosed area.
- At least 200 yards from a neighbor's buildings.
- Picked up within 72 hours (7 days if refrigerated to less than 45 degrees).
- Other: _____

Composting

The composting area will comply with the following:

- Built on an impervious, weight-bearing pad that is large enough to allow equipment to maneuver.
Note: Class V gravel material is not considered to be impervious.
- Covered with a roof to prevent excessive moisture on the composting material, but if sawdust or other water-repelling material is used as the bulking agent, a roof may not be necessary.
- Built of rot-resistant material that is strong enough to withstand the force exerted by equipment.
- Large enough to handle each day's normal mortality through the endpoint of the composting which consists of a minimum of two (2) heat cycles.
- Other: _____

Burial

The following operational practices will be implemented

- Stay 5 feet above seasonal high water table.
- Stay 1000 feet away from lakes and 300 feet away from rivers, streams, ditches, etc.
- Be covered immediately with enough soil to keep scavengers out (three feet is sufficient).
- Not be placed in sandy or gravelly soil types.
- Maintain at least 10 feet vertical separation between dead animals and bedrock.
- Other: _____

Incineration

The incinerator will meet the following:

- Capable of producing emissions not to exceed 20 percent opacity.
- Fitted with an afterburner that maintains flue gases at 1,200 degrees Fahrenheit for at least 0.3 seconds.
- Ash from the incinerator must be handled in such a manner as to prevent particulate matter from becoming airborne.

Other Method

The following operational practices will be implemented (describe the alternative method below)



Minnesota Pollution Control Agency

520 Lafayette Road North
St. Paul, MN 55155-4194

Emergency Response Plan

NPDES and SDS Permit Program

Feedlot Program

Doc Type: Permit Application

Applicability: This *Emergency Response Plan* is to be used in case of an emergency spill, leak, or failure at the production facility or land application area and to assist with response to catastrophic animal mortality events (barn fires, tornadoes, etc.). You must submit this form as part of an application for National Pollutant Discharge Elimination System (NPDES) or State Disposal System (SDS) feedlot permit coverage.

Facility name: Kyle Christensen Finisher Feedlot registration no.: _____
 Owner/Operator name: Kyle Christensen Feedlot permit no.: _____

List of critical phone numbers and contacts

	Contact person (or Company)	Phone number	
Emergency contacts			
• Fire/Ambulance	-----	911	
• County Sheriff	Redwood County	507-637-4036 or 911	
Agency contacts			
• Minnesota Duty Officer	-----	1-800-422-0798	Provide the Minnesota Duty Officer: • Your contact information • Incident location, date, and time • For spills – spill type – spill amount – surface water or field tile impacted • Progress made in response to the spill or catastrophic mortality event
• Minnesota Pollution Control Agency (MPCA) Field Office	Marshall Office	507-537-7146	
• County Feedlot Officer (CFO)	Redwood County	507-637-4023	
• Board of Animal Health Contact	St Paul Office	651-296-2942	
Other contacts			
• Insurance company	-----		
• Gopher State One Call	-----	1-800-252-1166	
•			
Local vendors for spill and/or catastrophic mortality response assistance			
• Manure pumper	Dan Loose	507-828-0375	
• Manure loading equipment	Dan Loose	507-828-0375	
• Earth moving equipment	Brey Tiling & Excavating	507-530-1921	
• Tiling equipment	Brey Tiling & Excavating	507-530-1921	
• Containment/Absorption materials (hay, straw, cornstalks, sawdust)	Brey Tiling & Excavating	507-530-1921	
• Mortalities	Central By Products	507-637-2938	

Manure Spill Emergency Response Procedures*

- Immediately stop the source of a liquid manure leak or spill:
 - Turn off pumps or valves
 - Clamp hoses or park tractor on hoses
- Contain spilled manure:
 - Use skid loader or tractor with blade to make berms
 - Install bale checks and block downstream culverts
 - Insert sleeves around tile intakes (or plug/cap)
 - Use tillage equipment to work ground ahead of spill
 - Use absorptive materials
- Make necessary phone calls as listed in the chart above:
 - Notify Minnesota Duty Officer at 1-800-422-0798
 - Notify sheriff's office if spilled on public roads or right-of-ways
- Cleanup:
 - Clean up spill immediately from road and roadside
 - Clean up all material, including the contaminated soil, as soon as possible by scraping, or by other means
 - Land apply manure at agronomic rates or place manure back in the manure storage area/ solid manure stockpile
 - Follow recommendations of MPCA staff and/or CFO
 - Restore site to its original conditions
 - If rain is expected prior to completion of cleanup; actions need to be taken to contain manure contaminated runoff from solid manure spills
- Document your actions:
 - Keep records of all actions related to the spill and follow up activities

*A detailed site map should be displayed on site to assist employees identify sensitive receptors near the facility (surface water, wells, tile intakes, etc.).

Catastrophic Animal Mortality Response

- Make necessary phone calls as listed in the chart above:
 - Notify Minnesota Duty Officer at 1-800-422-0798
 - Notify Minnesota Board of Animal Health
 - Notify MPCA and CFO
- Cleanup
 - Dispose of mortalities according to recommendations of MN Board of Animal Health Representative
 - Locate disposal area for mortalities to prevent impacts to surface and/or groundwater (consult MPCA/CFO)
- Document your actions
 - Keep records of all actions related to the animal mortality disposal activities

If burial of animal mortalities is necessary, the burial site must meet the following:

- Located 1000 feet from lakes and 300 feet from rivers and streams
- Mortalities are not buried within 5 feet of the seasonal water table
- Mortalities are not buried within 10 feet of karst susceptible bedrock
- Soils are not sandy or gravelly

Describe approximate location(s) of potential burial site(s) below:

March 4, 2016

Notice is hereby given per Minnesota Statutes, Chapter 116, that Kyle Christensen has made an application to the Minnesota Pollution Control Agency / County of Redwood for a permit to build a new livestock feedlot.

The new feedlot will be located in the SW ¼ of the NW ¼ of Section 14 in Granite Rock Township, in Redwood County, Minnesota. The proposed new finishing barn will be 102' by 200' and will hold 2,480 finishing pigs for a total of 744 animal units. The proposed new total confinement barn will have a below barn engineered concrete manure storage pit for approximately 13 months worth of manure storage. The total number of animal units on this site after building the new barn will be 744.

This publication shall constitute as notice to each resident and each owner of real property within 5000 feet of the perimeter of the proposed feedlot, as required by Minnesota State Law.

Estimated time frame of construction:	August thru October - 2016
Estimated time frame of occupancy:	October thru November - 2016

Sincerely,

Kyle Christensen
19426 - 250th Street
Lucan, MN 56255
507-828-3285

Land Application Agreement for Receiving Manure on Cropland

The undersigned landowner agrees to allow manure from Kyle Christensen's livestock feedlot to be spread on 150 acres of his/her land. The land is located in the SW one-quarter of Section 26, in Granite Rock Township, of Redwood County.

The undersigned landowner is the holder of Permit Number none (if none is held, please indicate none).

If the land indicated above received manure from livestock in addition to that from the feedlot indicated above, please list the number and types of livestock below (if none, please indicate none):

none

Enclose a Farm Service Agency aerial photo of all areas on which manure will be spread. Outline the areas used.

Signature of Landowner

This Agreement is Good Until _____

Name of Landowner

Phone Number

Address

City, State, Zip Code

Date

Return Form To:

Aerial Map

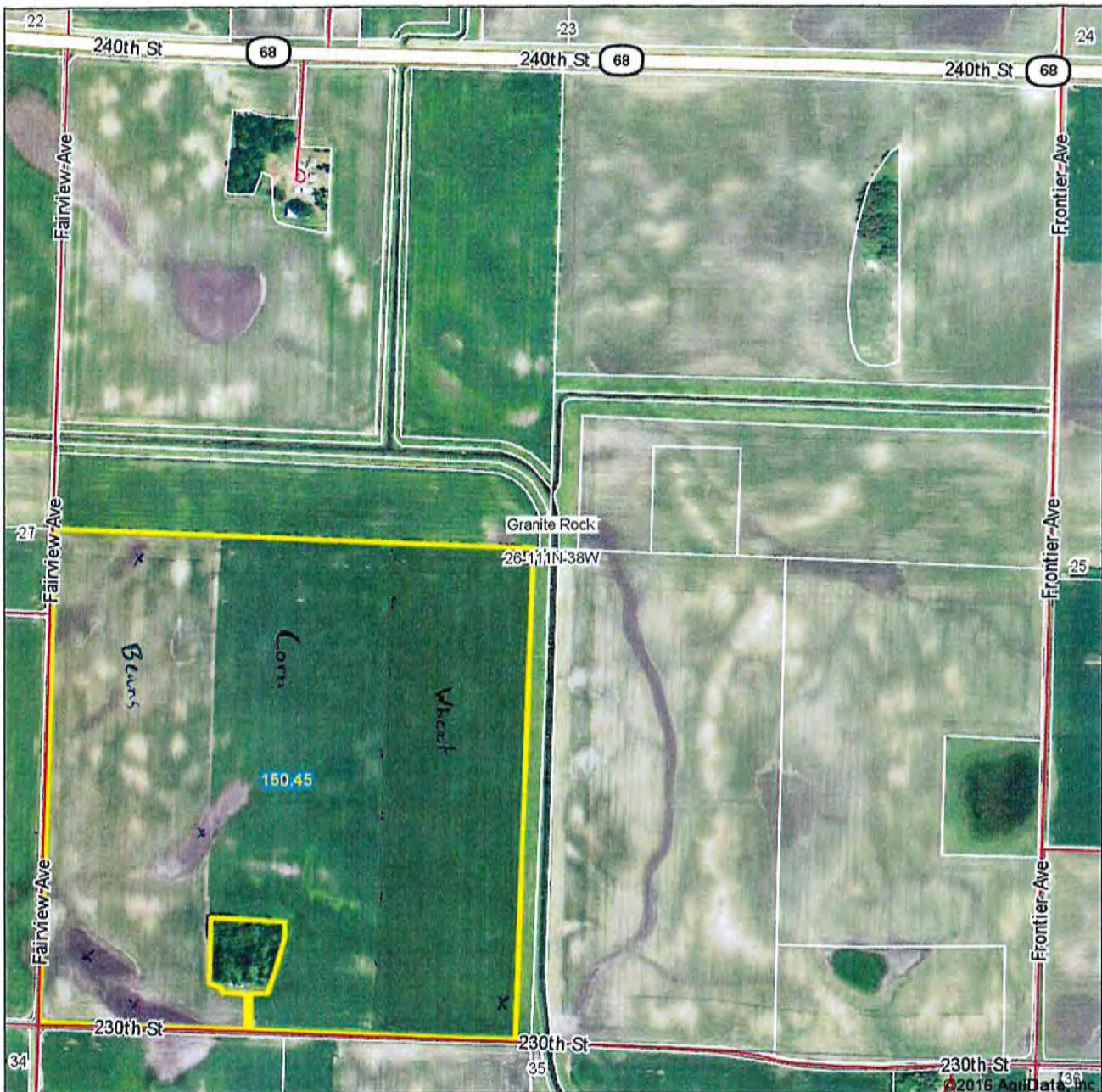

map center: 44° 23.4697', 95° 22.8162'

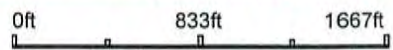

26-111N-38W
Redwood County
Minnesota



2016 Crops

Field borders provided by Farm Service Agency as of 5/21/2008.

*50 - wheat
50 - corn
50 - Beans*

Land Application Agreement for Receiving Manure on Cropland

The undersigned landowner agrees to allow manure from Kyle Christensen's livestock feedlot to be spread on 80 acres of his/her land. The land is located in the NE one-quarter of Section 22, in Granite Rock Township, of Redwood County.

The undersigned landowner is the holder of Permit Number none (if none is held, please indicate none).

If the land indicated above received manure from livestock in addition to that from the feedlot indicated above, please list the number and types of livestock below (if none, please indicate none):

none

Enclose a Farm Service Agency aerial photo of all areas on which manure will be spread. Outline the areas used.



Signature of Landowner

This Agreement is Good Until 2025

Shaun Fennern

Name of Landowner

507 828 8399

Phone Number

19525 250 st

Address

Lucan MN 56255

City, State, Zip Code

2-21-2016

Date

Return Form To:

Land Application Agreement for Receiving Manure on Cropland

The undersigned landowner agrees to allow manure from Kyle Christensen's livestock feedlot to be spread on 199 acres of his/her land. The land is located in the SE one-quarter of Section 29, in Granite Rock Township, of Redwood County.

The undersigned landowner is the holder of Permit Number None (if none is held, please indicate none).

If the land indicated above received manure from livestock in addition to that from the feedlot indicated above, please list the number and types of livestock below (if none, please indicate none):

None

Enclose a Farm Service Agency aerial photo of all areas on which manure will be spread. Outline the areas used.

Signature of Landowner

This Agreement is Good Until 1-1-2021

Brian D Johnson
Name of Landowner

507-336-2445 (H) 419-733-5222 (C)
Phone Number

23648 Camp Ave
Address

Milroy MN 56263
City, State, Zip Code

2-21-2016
Date

Return Form To:

Aerial Map



©2016 AgriData, Inc.

map center: 44° 23.4805', 95° 21.5795'

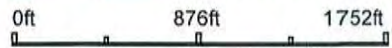

25-111N-38W
Redwood County
Minnesota



2/19/2016

2016 Beans West 77.5 Acres
2014 Corn East 77.5 Acres

Field borders provided by Farm Service Agency as of 5/21/2008.

Land Application Agreement for Receiving Manure on Cropland

The undersigned landowner agrees to allow manure from Kyle Christensen's livestock feedlot to be spread on 112 acres of his/her land. The land is located in the SE one-quarter of Section 15, in Granite Rock Township, of Redwood County.

The undersigned landowner is the holder of Permit Number none (if none is held, please indicate none).

If the land indicated above received manure from livestock in addition to that from the feedlot indicated above, please list the number and types of livestock below (if none, please indicate none):

none

Enclose a Farm Service Agency aerial photo of all areas on which manure will be spread. Outline the areas used.

Robert Christensen
Signature of Landowner

This Agreement is Good Until 2025

Robert Christensen
Name of Landowner

877-828-8558
Phone Number

19426 250 ST.
Address

LUCAN MI 49625
City, State, Zip Code

2-22-16
Date

Return Form To:



Land Application Agreement for Receiving Manure on Cropland

The undersigned landowner agrees to allow manure from Kyle Christensen's livestock feedlot to be spread on 94 acres of his/her land. The land is located in the NW one-quarter of Section 25, in Granite Rock Township, of Redwood County.

The undersigned landowner is the holder of Permit Number None (if none is held, please indicate none).

If the land indicated above received manure from livestock in addition to that from the feedlot indicated above, please list the number and types of livestock below (if none, please indicate none):

None

Enclose a Farm Service Agency aerial photo of all areas on which manure will be spread. Outline the areas used.

Robert Christensen

Signature of Landowner

This Agreement is Good Until 2025

Robert Christensen

Name of Landowner

507-828-8558

Phone Number

19426 25th ST

Address

LUCAN MN 56255

City, State, Zip Code

2-22-16

Date

Return Form To:

Aerial Map

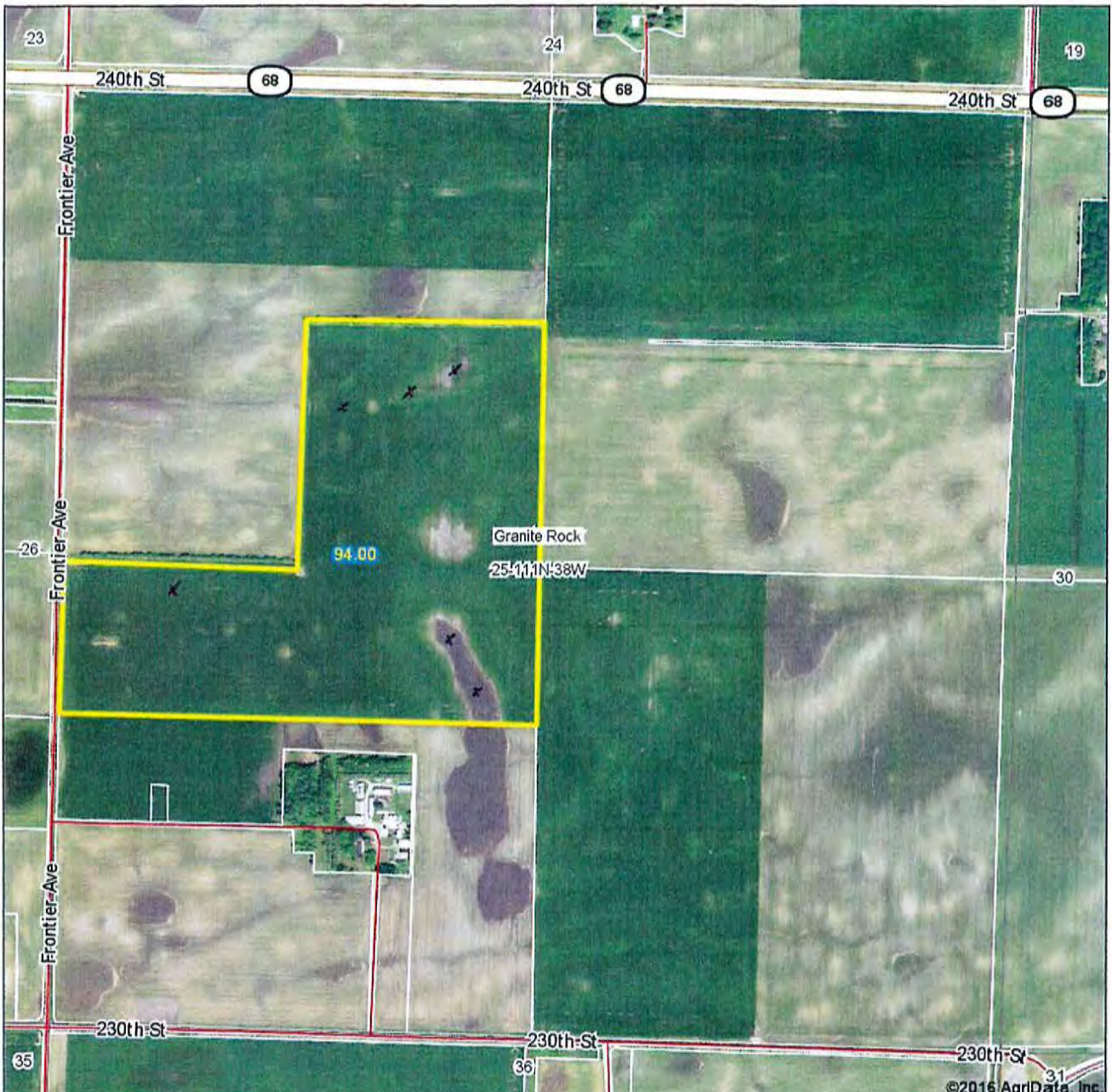

map center: 44° 23.4805', 95° 21.5795'

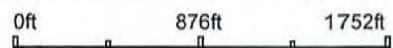

**25-111N-38W
Redwood County
Minnesota**



2016 Beans

2/19/2016

Field borders provided by Farm Service Agency as of 5/21/2008.

Land Application Agreement for Receiving Manure on Cropland

The undersigned landowner agrees to allow manure from Kyle Christensen's livestock feedlot to be spread on 43 acres of his/her land. The land is located in the NW one-quarter of Section 14, in Granite Rock Township, of Redwood County.

The undersigned landowner is the holder of Permit Number none (if none is held, please indicate none).

If the land indicated above received manure from livestock in addition to that from the feedlot indicated above, please list the number and types of livestock below (if none, please indicate none):

none

Enclose a Farm Service Agency aerial photo of all areas on which manure will be spread. Outline the areas used.

Robert Christensen

Signature of Landowner

This Agreement is Good Until 2025

Robert Christensen

Name of Landowner

507-828-8558

Phone Number

19426 250 ST.

Address

LUCAN MN 56255

City, State, Zip Code

2-22-16

Date

Return Form To:

Aerial Map

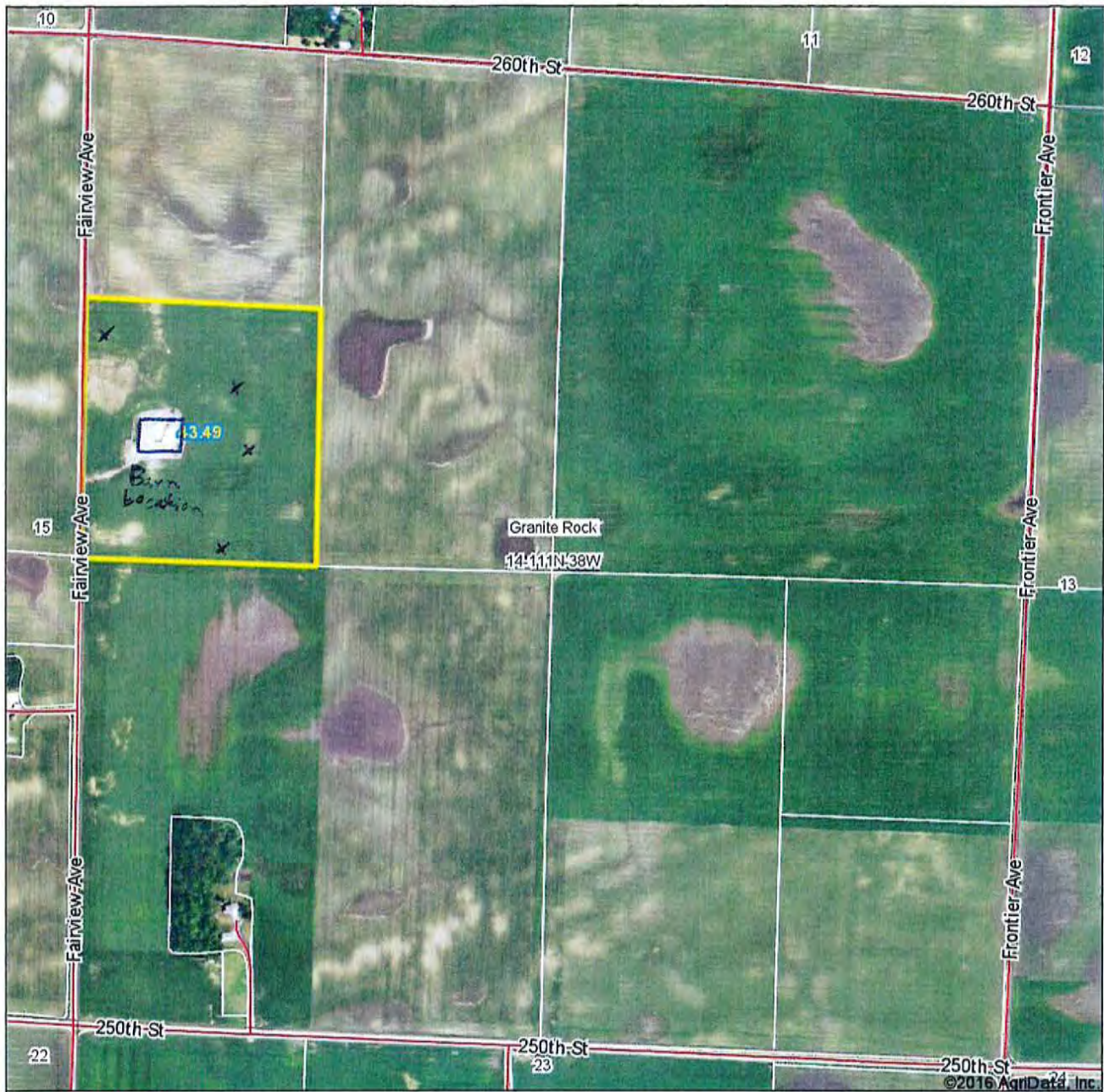

map center: 44° 25.2395', 95° 22.8265'

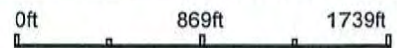

14-111N-38W
 Redwood County
 Minnesota

2016 Beans



Field borders provided by Farm Service Agency as of 5/21/2008.

Land Application Agreement for Receiving Manure on Cropland

The undersigned landowner agrees to allow manure from Kyle Christensen's livestock feedlot to be spread on 38 acres of his/her land. The land is located in the SW one-quarter of Section 22, in Grand Fork Township, of Redwood County.

The undersigned landowner is the holder of Permit Number _____ (if none is held, please indicate none).

If the land indicated above received manure from livestock in addition to that from the feedlot indicated above, please list the number and types of livestock below (if none, please indicate none):

None

Enclose a Farm Service Agency aerial photo of all areas on which manure will be spread. Outline the areas used.

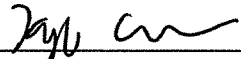
Signature of Landowner

This Agreement is Good Until _____

Kyle Christensen
Name of Landowner

507-828-3285
Phone Number

19426 250th St
Address

Wscan MN 56255
City, State, Zip Code

2/21/16
Date

Return Form To:

Aerial Map

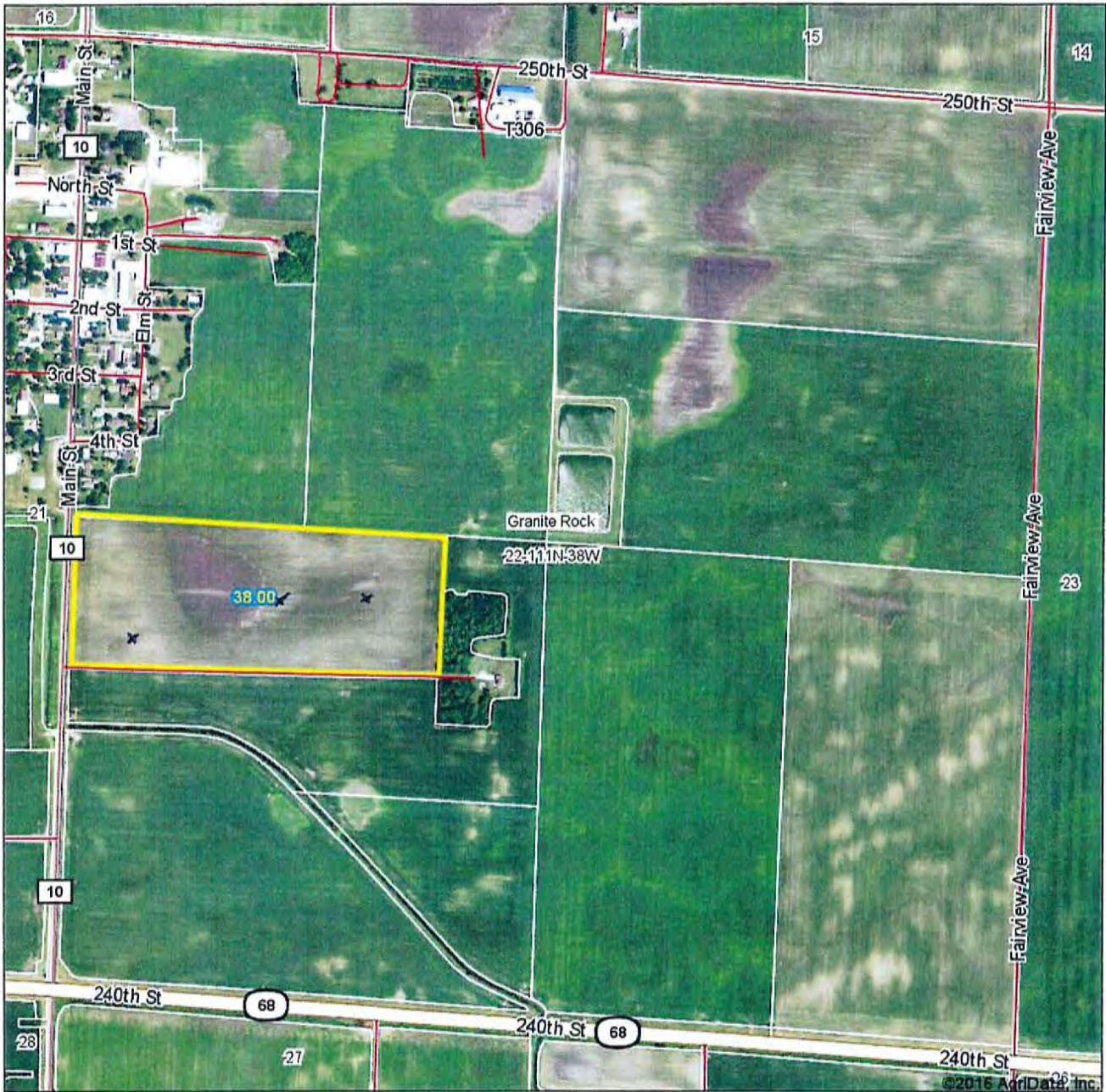

map center: 44° 24.3677', 95° 24.0308'

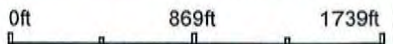

22-111N-38W
Redwood County
Minnesota



2016 Corn.

2/19/2016

Field borders provided by Farm Service Agency as of 5/21/2008.

Land Application Agreement
for Receiving Manure on Cropland

The undersigned landowner agrees to allow manure from Kyle Christensen's livestock feedlot to be spread on 150 acres of his/her land. The land is located in the SW one-quarter of Section 22, in Granite Rock Township, of Redwood County.

The undersigned landowner is the holder of Permit Number none (if none is held, please indicate none).

If the land indicated above received manure from livestock in addition to that from the feedlot indicated above, please list the number and types of livestock below (if none, please indicate none):

none

Enclose a Farm Service Agency aerial photo of all areas on which manure will be spread. Outline the areas used.

Lydia Trust 2
By Kyle Christensen
Signature of Landowner

This Agreement is Good Until 2026

Lydia Trust 2

Name of Landowner

320-246-3512
Phone Number

Address

W670 610th ave

City, State, Zip Code

Chickoma 56221

Date

3-14-2016

Return Form To:

Redwood County Swine Composting Protocol:

- I. Purpose and scope: To allow hog producers to compost their dead livestock (carcasses) in lieu of rendering. These guidelines are based upon Minnesota Rules 1719 (Board of Animal Health), which are incorporated herein by reference. In any instance where these guidelines diverge from Minnesota Rules 1719, the stricter rule shall control.
- II. Site selection – must take into account:
 - a. Prevailing winds – reasonable attempts must be made to avoid sites where the prevailing winds will carry odors onto neighboring land uses (excepting agricultural fields and feedlots).
 - b. Public view – the compost facility must be shielded from public view, so that the composting material is not visible from public roadways or neighboring land uses.
- III. Facility – requirements for construction:
 - a. Overall design: Compost facility must consist of at least three (3) compost bays each with 20 cubic feet of area for every one (1) pound daily normal mortality. Each bay must have poured concrete walls on three sides and be gated on the front so that wild and domestic animals cannot access the compost. The entire structure must sit on a concrete pad and have a roof to deflect rainwater from the compost.
 - b. Floor: Floor must be constructed of 5” thick impervious concrete. Floor must be sloped toward the rear of the facility to keep liquid from running out of the composting area onto the ground.
 - c. Walls: Walls must be constructed of 6” thick impervious concrete. Cement walls must be no more than 5’ high. If lower than 5’, the walls must include fencing up to 5’ to prevent wild or domestic animals from accessing the compost. Cement walls must be high enough to contain the compost material.
 - d. Roof: Roof must be supported by treated wood or metal supports and rafters. Roof must completely cover the composting bays so as to deflect rainwater.
- IV. Process – the following practices must be observed:
 - a. Dead pigs must be added within 24 hours of death.
 - b. Each composting bay shall begin with a 1’ layer of litter. Thereafter, carcasses shall be stacked up to 1’ and covered by 1’ of litter. Add additional layers as needed.
 - c. Litter can be finely chopped vegetable matter (such as corn stalks), sawdust, or finished compost. The carbon to nitrogen ratio must be in the range of 15:1 to 35:1.
 - d. Carcasses must be kept at least 6” from the edge of the compost bay.
 - e. The 3 compost bays allow for a three stage composting process. When the first bay is full, start a new pile in the second bay. When the second bay is full, start a new pile in the third bay. When the third bay is full, empty the first bay and start over. Turn each bay every 7 to 10 days. Add water as necessary to keep up the heat.
 - f. Temperature:
 - i. Must be taken and recorded in each bay daily.
 - ii. Must be at least 130 degrees Fahrenheit.
 - iii. Temperature records must be kept on hand for 2 years.
- V. Protocol:
 - a. Must keep a written composting protocol describing the composting steps on-site.
 - b. Must instruct all employees on-site about the protocol.
- VI. Pests, such as flies and rodents, must be controlled
- VII. Transportation of Carcasses on public roads:
 - a. An owner who transports the owner’s own carcasses does not need a permit to do so.
 - b. Carcasses transported on public roads must be in leak-proof, covered containers.
- VIII. Finished compost:
 - a. Must contain no visible soft tissue pieces.
 - b. May be handled and stored according to PCA and Dept. of Agriculture rules.

Conditions for Permit No. 5-16 (Kyle Christen – Robert Christensen site)

1. The permit holder shall comply with all applicable laws, rules, and regulations, including but not limited to Redwood County Ordinance, as hereafter amended from time to time.
2. The permit holder shall allow the Redwood County Environmental Office to inspect the site for all purposes permitted by law whenever deemed necessary by the Redwood County Environmental Office.
3. All waste, refuse, and the like generated by or from the conditional use must be disposed of in the manner provided by the applicable local, state, and federal statutes, rules, and regulations. A copy of all disposal records and receipts must be kept on file for no less than five (5) years and shall be provided to the Redwood County Environmental Office upon request.
4. The permit holder shall contact all relevant local, state, and federal authorities/entities and inquire as to whether a permit and/or license is required. If a permit and/or license is required, the permit holder shall apply for and obtain any and all required permits and/or licenses. A copy of all such permits and/or licenses shall be provided to the Redwood County Environmental Office upon request.
5. The permit holder shall take appropriate and reasonable measures to assure that all surface water runoff satisfies all applicable local, state, and federal discharge standards.
6. The permit holder shall not allow the conditional use to be injurious to the use and enjoyment of other property in the immediate vicinity for the purposes already permitted.
7. The permit holder shall not allow the conditional use to impede the normal and orderly development and improvement of surrounding vacant property for uses predominant to the area.
8. Adequate utilities, access roads, drainage, and other necessary facilities shall be provided and continue to be provided by the permit holder now and in the future.
9. Adequate measures shall be taken to prevent or control offensive odor, fumes, dust, and vibration, so that none of the foregoing will constitute a nuisance now or in the future.
10. The manner in which manure is stored and disposed of shall comply with all applicable local, state, and federal laws, rules, and regulations. If manure is applied to land, it shall be applied to land at agronomic rates. The permit holder shall retain a record of all locations where manure is applied to land. Such records shall be maintained for a period of no less than five (5) years, measured from the date the manure is applied to land. Such records shall be submitted to the Redwood County Environmental Office upon request.
11. The permit holder shall report any changes in spread agreements or spread areas to the Redwood County Environmental Office within thirty (30) days subsequent to any such change.

12. The County Board of Commissioners may at any time impose additional conditions as necessary and appropriate including but not limited to: the planting of trees and shrubs for use as a windbreak for the feedlot operation; the furnishing and placing in a dedicated account, to be administered by the County, an annual payment for reclamation purposes based upon the number of Animal Units involved; and restrictions on the days on which a manure storage structure may be disturbed or manure may be transferred, applied, incorporated, or injected.
13. Dead livestock shall be stored and rendered in such a manner as to not create a nuisance. Disposal of dead livestock by burial is strictly prohibited. Dead hogs may be composted according to the Redwood County Swine Composting Protocol, which is attached hereto and incorporated into Conditional Use Permit #5-16.
14. The permit holder shall construct the manure storage structure/concrete pit(s) to meet or exceed the minimum requirements set forth in the plans and specifications prepared by Jason E. Hoehn and signed by him on January 13, 2016, attached to the permit holder's application.
15. A perimeter tile line shall be installed around the outside of the base of the pit(s) walls and an inspection manhole shall be provided where the perimeter tile branches out into the local drain tile system.
16. The permit holder shall install a warning sign at all entrances to the concrete pits. These signs shall warn the reader of the dangers of entering the pits.
17. The Redwood County Environmental Office shall be contacted for two on-site inspections during the construction of the pits: once when the floor is ready to be poured, and once when the walls are ready to be poured.
18. No construction on the pit shall be done between October 15th and April 15th, except by approval of the Zoning Administrator.
19. The Redwood County Planning Commission shall review the conditional use permit and shall be authorized to take any and all necessary action(s), including but not limited to revoking the conditional use permit and/or requiring the permit holder to reapply for a conditional use permit, if: 1) The Redwood County Environmental Office acquires information previously unavailable that indicates the terms and conditions of the permit do not accurately represent the actual circumstances of the permitted facility or the conditional use; 2) It is discovered subsequent to the issuance of the permit the permit holder failed to disclose all facts relevant to the issuance of the permit or submitted false or misleading information to the Redwood County Environmental Office, the Redwood County Planning Commission, or the Redwood County Board of Commissioners; 3) The Redwood County Environmental Office determines the permitted facility or conditional use endangers human health or the environment; and/or (4) The permit holder violates any of the herein described conditions, the Redwood County Ordinances, State statutes, or Federal laws.

Factors Regarding a Request for a Conditional Use Permit¹

Redwood County Ordinance Factors

The County Planning Commission shall recommend no conditional use unless said Commission shall find:

1. That the conditional use will not be injurious to the use and enjoyment of other property in the immediate vicinity for the purposes already permitted, nor substantially diminish and impair property values within the immediate vicinity.
2. That the establishment of the conditional use will not impede the normal and orderly development and improvement of surrounding vacant property for uses predominant to the area.
3. That adequate utilities, access roads, drainage and other necessary facilities have been or are being provided.
4. That adequate measures have been or will be taken to provide sufficient off street parking and loading space to serve the proposed use.
5. That adequate measures have been or will be taken to prevent or control offensive odor, fumes, dust, noise and vibration, so that none of these will constitute a nuisance, and to control lighted signs and other lights in such a manner that no disturbance to neighboring properties will result.²

¹ See M.S.A. § 394.301, Subd. 1 (stating, in relevant part, "...[c]onditional uses may be approved upon a showing by an applicant that standards and criteria stated in the ordinance will be satisfied. Such standards and criteria shall include both general requirements for all conditional uses and, insofar as practicable, requirements specific to each designated conditional use."). See also Schwardt v. County of Watonwan, 656 N.W.2d 383, 387 (Minn. 2003) (stating "[b]y statute, counties may approve conditional uses if the applicant satisfies the standards set out in the country ordinance.") (citing Minn.Stat. §394.301, Subd. 1); Corwine v. Crow Wing County, 244 N.W.2d 482, 486 (Minn. 1976).

² Requirement of Section 25, Subdivision 5 of Redwood County Ordinance.

Application for Conditional Use Permit #5-16
Kyle Christensen (Robert Christensen site)

Based upon the facts presented, the Redwood County Planning Commission hereby establishes the following findings and conclusions (check all factors that apply):

- The conditional use will not be injurious to the use and enjoyment of other property in the immediate vicinity for the purposes already permitted, nor substantially diminish and impair property values within the immediate vicinity.

- The establishment of the conditional use will not impede the normal and orderly development and improvement of surrounding vacant property for uses predominant to the area.

- Adequate utilities, access roads, drainage and other necessary facilities have been or are being provided.

- Adequate measures have been or will be taken to provide sufficient off street parking and loading space to serve the proposed use.

- Adequate measures have been or will be taken to prevent or control offensive odor, fumes, dust, noise and vibration, so that none of these will constitute a nuisance, and to control lighted signs and other lights in such a manner that no disturbance to neighboring properties will result.

DATED: _____

Redwood County Planning Commission



CONSTRUCTION METHODS FOR CONCRETE LINED HOG BARN PITS

Prepared For:

KYLE CHRISTENSEN

19426 250th Street

Lucan, MN 56255

NW ¼, Section 14, T111N-R38W

Granite Rock Township, Redwood County

January 2016

Project No. 16-18701



January 13, 2016

Kyle Christensen
19426 250th Street
Lucan, MN 56255

Re: Soil Borings for a 102'x200' Finishing Barn

Dear Mr. Christensen:

On January 8, 2016, ISG was present during excavation of 2 observation pits and recorded the soil profiles. A backhoe was used to excavate the 2 test holes. After recording the soil profiles, the holes were backfilled and compacted by placing the soil in the holes to provide the original soil profile.

The seasonal high water table was at 36". The water table will be controlled by using a 4" perforated drain tile installed to gravity-drain to an existing farm tile of sufficient depth. This tile will prevent any ground water intrusion and damage to the concrete pit walls.

We have reviewed the concrete pit design along with the soils report and find the soils to be acceptable for this project.

If you have any questions, please call.

Sincerely,

A handwritten signature in red ink that reads "Jason E. Hoehn".

Jason E. Hoehn, P.E.

JEH/mdh

115 East Hickory Street, Suite 300 + Mankato, MN 56001

info@is-grp.com + www.is-grp.com

P: 507.387.6651

I+S GROUP



SOIL BORING #1

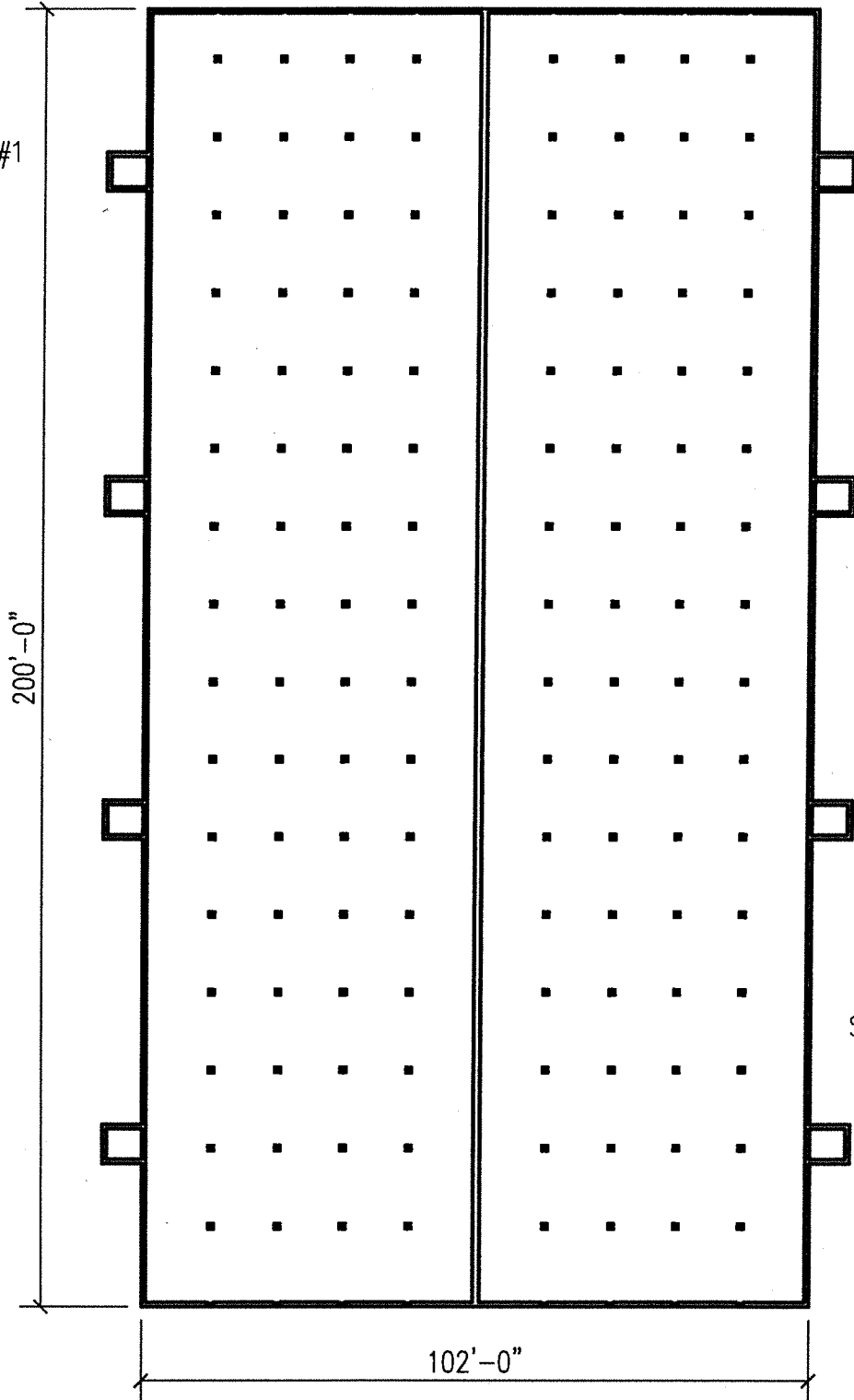

SOIL PROFILE LOCATIONS

KYLE CHRISTENSEN
SECTION 14, GRANITE ROCK TWP., REDWOOD CO.
PROJECT NO. 16-18701



SOIL BORING REPORT

I+S GROUP

Test No: 1

Project Name: Kyle Christensen
I&S Project Number: 16-18701
Location: NW 1/4 Section 14
Township: Granite Rock, T111N, R38W
County: Redwood
Description: 102'x200' Hog Barn

Date: 1/8/2016
Temp: 32 Deg.
Conditions: Overcast, Light Snow
Inspector: Matt Hudson

Assum. Elev.	Depth	USCS Symbol	Description of Materials	WL	SH	Notes
1104.00'	+48"					Proposed Slat Elevation
			Topsoil already striped away			
1100.00'	0"					Existing Grade
		10yr 4/2	Sandy Clay			
1096.00'	-48"					Proposed Pit Floor Elevation
1095.83'	-50"					Seasonal High Water Table
		10yr 5/6	Sandy Clay w/ mottling			
		10yr 6/2				
1094.00'	-72"					Ground Water During Test
		10yr 4/6	Sand			
1090.42'	-115"					End of Soil Boring

Nearest Body of Water:	Location: South	Type: Drainage Ditch	Distance: 4300'	Approx. Elev.: 1075.00'
-------------------------------	------------------------	-----------------------------	------------------------	--------------------------------



SOIL BORING REPORT

I+S GROUP

Test No: 2

Project Name: Kyle Christensen
I&S Project Number: 16-18701
Location: NW 1/4 Section 14
Township: Granite Rock, T111N, R38W
County: Redwood
Description: 102'x200' Hog Barn

Date: 1/8/2016
Temp: 32 Deg.
Conditions: Overcast, Light Snow
Inspector: Matt Hudson

Assum. Elev.	Depth	USCS Symbol	Description of Materials	WL	SH	Notes
1104.00'	+48"					Proposed Slat Elevation
1100.00'	0"					Existing Grade
1098.83'	-14"	10yr 2/1	Topsoil			
		10yr 4/2	Sand			
1097.00'	-36"					Seasonal High Water Table
1096.00'	-48"					Proposed Pit Floor Elevation
1094.00'	-72"					Ground Water During Test
		10yr 5/6 10yr 6/2	Sandy Clay w/ mottling			
1089.00'	-132"					End of Soil Boring

Nearest Body of Water:	Location: South	Type: Drainage Ditch	Distance: 4300'	Approx. Elev.: 1075.00'
-------------------------------	------------------------	-----------------------------	------------------------	--------------------------------

CONCRETE LINED STORAGE STRUCTURE

A Concrete lined manure structure is a fabricated structure for the temporary storage of animal or other organic wastes to conserve nutrients, prevent pollution and protect the environment. The following guidelines are provided for your use in operating and maintaining your structure:

- A.** Animal manure shall be handled and utilized as specified in the Manure Management plan.
- B.** Poisonous, noxious or explosive gases produced in the tank must be controlled by ventilation. Evacuate the building if practical during agitation.
- C.** Regular inspection should be made of the structure and its surroundings for leaks, deterioration of grills, slats, covers, and ladders. Deteriorating items should be replaced to avoid future accidents.
- D.** Concrete should be checked for large cracks, which could expose the reinforcing steel to corrosive elements. Joints should be inspected for unusual openings.
- E.** Concrete surfaces should be checked for erosion, scaling and exposed reinforcing steel.
- F.** If any concrete deterioration is evident, call your local MPCA office. Depending on the damage, an engineer may be needed to evaluate the pit and propose a solution.
- G.** Regular inspections should be made of the perimeter tile, shut off valves, and inspection risers to ensure proper operations of the system.

PRE-CONSTRUCTION MEETING

A pre-construction meeting is a meeting that involves the owner, the contractor, the design engineer, the inspector and the MPCA or the County feedlot officer. The object of the meeting is to ensure that the structure is built to comply with the rules of the MPCA and the designed plans. Any questions or comments can be discussed at this meeting. Any changes to the plans or specifications must be submitted to the Engineer and the MPCA / County prior to the start of construction.

The project schedule, proper notifications, contact information for contractors, owners, MPCA and County Feedlot Officer, and any sub-contractor information will be discussed at this meeting.

The Pre-construction meeting shall be scheduled at least one week before construction is to begin on the structure. This will be determined mainly by when the contractor can begin work and the owner and engineer's agreement to the timing of the meeting. A time of day and location for the meeting shall be agreed upon by the contractor, owner, design engineer and inspector. The owner shall be responsible for contacting all of the above and scheduling the meeting.

INSPECTION PLAN

An owner constructing a liquid manure storage area, except for concrete lined manure storage areas with a capacity of 20,000 gallons or less, shall have plans designed by a licensed engineer and inspections completed during the construction process which comply with the following:

- A. The inspector must be one or more of the following:
 - 1. A professional engineer licensed in the State of Minnesota or a person working under the Professional Engineer's direct supervision;
 - 2. A qualified Natural Resources Conservation Services Staff Person; or
 - 3. If the manure storage area has a concrete liner, an American Concrete Institute or Minnesota Department of Transportation concrete field testing technician grade/level I certified and concrete field inspector level II certified.

- B. The General Contractor / Owner is required to call the inspector a minimum of 48 hours prior to beginning excavation and 24 hours prior to placing concrete. Contact will be kept with the inspector throughout the project until the concrete lined storage area is complete.

- C. The General Contractor / Owner is required to call the MPCA / County Feedlot Officer 3 days before any construction activity begins.

- D. The General Contractor / Owner is required to call the MPCA / County Feedlot Officer 3 days before the perimeter pit walls are backfilled. A final inspection by the MPCA / County Feedlot Officer is required prior to backfill.

- E. During construction of each manure storage area the inspector shall record observations related to conformance to the design plans and specifications and construction standards of the following:
 - 1. Subgrade conditions prior to liner placement including soil texture, strength and moisture content, and presence of any frozen soils;
 - 2. Location and proper functioning of the perimeter drainage tile system, if required, and inspection/monitoring access;
 - 3. For all concrete-lined manure storage areas:
 - a. Reinforcing steel size, grade, spacing, cover, and that steel is free of loose rust, oil, or other debris;

- b. Handling, placement, consolidation, and finishing of concrete;
 - c. Curing and protection of concrete after placement, including hot and cold weather protective measures;
 - d. Location, forming, and surface preparation of construction, contraction, and expansion joints;
 - e. Placement of flexible waterstop materials in joints; and
 - f. Application of surface applied or injected crack and joint sealant materials;
4. Repair of construction defects; and
 5. Conformance to the liner penetration prohibitions

F. Concrete Testing:

1. A test of concrete shall include all of the following: Cylinders, Slump, Air Content and Temperature. A test shall be taken once every 100 cubic yards of concrete placed and at least one test every day 10 or more cubic yards of concrete are placed. Additional testing is required to represent new mixes and different concrete suppliers.
2. Three (3) concrete cylinders shall be taken for each 100 cubic yards of concrete placed but not less than three 3 test cylinders each day that 10 or more cubic yards are placed. Keep one of each three cylinders on the job site and allow to field cure. Within two days, deliver two of the three cylinders to a licensed testing laboratory to be cured and tested at seven 7 days and 28 days. Additional testing and cylinders are required to represent new mixes and different concrete suppliers.
3. Concrete Rebound Hammer tests may be taken after the pit is complete and at least 7 days after the concrete to be tested was poured. Concrete shall be tested according to ASTM C 805.

G. The owner shall ensure that the following information is submitted to the Design Engineer for incorporation into the construction report.

1. The name and qualifications of the inspector;
2. The name of the Concrete Contractor.



Liquid Manure Storage Area Construction Inspection Form

Feedlot Program

Doc Type: Inspection

Applicability: This form must be utilized to document construction of a liquid manure storage area (LMSA). Both the required inspector and the contractor that installed the LMSA liner must contribute information to this form. This form must be provided to the design engineer to incorporate into the final construction report. All instances of construction of a LMSA must utilize this form except for LMSAs that are concrete-lined with a capacity of 20,000 gallons or less or for those that qualify for the exemption of Minn. R. 7020.2100, subp 1. item D or E.

Return this completed form to the design engineer: The owner must submit a construction report to the Minnesota Pollution Control Agency (MPCA) or county feedlot pollution control officer within 60 days of the completion of any new or modified manure storage area. The report must be prepared and signed by the design engineer and must contain an assessment of whether the completed manure storage area conforms to the design plans and specifications submitted to the commissioner or county feedlot pollution control officer.

I. Facility Information

Name of owner(s): _____
Legal name of facility: _____ Permit number _____
Location: _____
County Township Sect. ¼ Sec. ¼ of ¼

II. Inspector's Information *(inspector must complete Parts 3 to 6 of this form)*

Name of inspector: _____ Phone: _____
Company/Agency: _____

Inspector qualifications (check all that apply):

- Professional engineer licensed in the state of Minnesota. License No.: _____
- Person working under the direct supervision of a professional engineer.
Engineer's name: _____ MN license no.: _____
- Natural Resources Conservation Services staff.
- American Concrete Institute (ACI) or Minnesota Department of Transportation (MNDOT) concrete field testing technician Grade/Level I certified and concrete field inspector Level II certified.
Note: For concrete-lined structures only. List certificate no.: _____

III. Notifications

- A. Did the owner notify the **design engineer** a minimum of three business days *prior to commencement of construction*? Yes No
Date notification given: _____
(mm/dd/yyyy)
- B. Did the owner notify the **MPCA or county feedlot officer** a minimum of three business days *prior to commencement of construction*? Yes No
Date notification given: _____
(mm/dd/yyyy)
- C. Did the owner notify the MPCA or county feedlot officer within three business days *following completion of the manure storage area liner*? Yes No
Date notification given: _____
(mm/dd/yyyy)
- 1. If a concrete-lined structure, did the owner complete the notice before the vertical walls of the concrete structure were backfilled? Yes No N/A

IV. Inspection Checklist and Observations

This section (A-H, below) must be completed by the inspector listed in Part II. The liner contractor does not need to complete this section. Attach additional sheets for comments as needed.

	Yes	No	N/A
A. Were subgrade conditions adequate for liner placement, including soil texture, strength, and moisture content, and no frozen soils were present? Comments:	<input type="checkbox"/>	<input type="checkbox"/>	
B. Was a perimeter drain tile system specified in the design plans? If yes, answer Questions 1 to 4. If no, go to Question C.	<input type="checkbox"/>	<input type="checkbox"/>	
1. If concrete-lined, is drainage tile located a horizontal distance of at least 1 ft. outside the footing of a concrete-lined structure (unless incorporated into the form material)?	<input type="checkbox"/>	<input type="checkbox"/>	
2. Is a dedicated drain tile system in place for each manure storage area?	<input type="checkbox"/>	<input type="checkbox"/>	
3. Is a dedicated tile riser, manhole, or other access (i.e. daylight) that allows collection of tile-water samples in place and functioning for each dedicated tile system? Comments:	<input type="checkbox"/>	<input type="checkbox"/>	
C. Concrete-lined LMSAs only - Did you verify that the following items (1-7 below) were in conformance with the design engineer's plans and specifications:	<input type="checkbox"/>	<input type="checkbox"/>	<input type="checkbox"/>
1. Reinforcing steel size, grade, spacing, cover, and that steel was free of loose rust, oil, or other debris?	<input type="checkbox"/>	<input type="checkbox"/>	
2. Concrete quality for air entrainment, temperature, and strength? (include test results with photocopy of laboratory results for strength)	<input type="checkbox"/>	<input type="checkbox"/>	
3. Handling, placement, consolidation, and finishing of concrete?	<input type="checkbox"/>	<input type="checkbox"/>	
4. Curing and protection of concrete after placement, including hot and cold weather protective measures?	<input type="checkbox"/>	<input type="checkbox"/>	
5. Location, forming, and preparation of construction and contraction/expansion joints?	<input type="checkbox"/>	<input type="checkbox"/>	
6. Specified product, placement, and installation of flexible waterstop materials in joints?	<input type="checkbox"/>	<input type="checkbox"/>	
7. Specified product and installation of surface applied or injected crack and joint sealant materials? Comments:	<input type="checkbox"/>	<input type="checkbox"/>	
D. Were there any construction defects that needed repair? If yes, describe:	<input type="checkbox"/>	<input type="checkbox"/>	
E. Were any water supply systems, fuel lines, electrical conduit, or other equipment not solely functioning as part of the manure handling or transfer system installed to penetrate the liner of the liquid storage structure?	<input type="checkbox"/>	<input type="checkbox"/>	
F. Was testing completed according to the methods and frequencies specified in the design engineer's quality assurance and quality control plan? (results should be forwarded to the engineer)	<input type="checkbox"/>	<input type="checkbox"/>	
G. Were any engineering changes or modifications made related to the liner specifications, structure location, depth, or separation distance to bedrock? If yes, complete 1 and 2 below:	<input type="checkbox"/>	<input type="checkbox"/>	
1. Describe the changes:			
2. Were these changes approved by the MPCA or county feedlot officer prior to commencement of construction of the change?	<input type="checkbox"/>	<input type="checkbox"/>	
H. Other comments:			

V. Inspector's Certification

I hereby certify that I am the inspector listed in Part II of this form. I hereby certify that the construction of the facilities referenced in this form were completed in accordance with all plans, specifications, reports, permit application submittals, and related communications approved by the MPCA or delegated county feedlot officer. By my signature below, I represent that the information submitted in this form is, to the best of my knowledge and belief, true, accurate, and complete.

Signature of Inspector: _____

Date: _____

VI. Contractor's Information and Certification

Contact name: _____

Phone: _____

Liner Contractor Company: _____

Indicate type of liner installed: Earthen Concrete Steel Tank HDPE, LLDPE, or EPDM GCL (bentonite)
(Check all that apply) Other: _____

I hereby certify that I represent the liner contractor and further certify that the construction of the liner indicated above, was completed in accordance with the design plans and specifications and construction standards.

Signature of Contractor: _____

Date: _____

Second Liner Contractor (if used)

Contact name: _____

Phone: _____

Liner Contractor Company: _____

Indicate type of liner installed: Earthen Concrete Steel Tank HDPE, LLDPE, or EPDM GCL (bentonite)
(Check all that apply) Other: _____

I hereby certify that I represent the liner contractor and further certify that the construction of the liner indicated above, was completed in accordance with the design plans and specifications and construction standards.

Signature of Contractor: _____

Date: _____

OPERATION AND MAINTENANCE PLAN

A plan for operation, inspections, and maintenance of the manure storage area should be created to ensure the quality of the existing pit.

A. Pit Inspections & Maintenance:

1. Routine inspections should be made of the structure and its surroundings for leaks, deterioration of grills, slats, covers, and ladders.
 - a. Monitor the frequency of manure removal from the storage structure and note any significant fluctuations (an increase or decrease) in time between successive manure removal events.
 - b. Control the level of the liquid manure inside such that the maximum operating depth is not exceeded.
 - c. Records shall be kept explaining the type of defects, location, and repair methods. If any leaking is detected, contact your local MPCA office.
 - d. Prior to initial manure loading, consult with the design engineer to determine the need for protecting the foundation and floor slab from freezing temperatures. It may be advisable to add water to the structure to prevent frost damage. It may also be advisable to obtain, and have analyzed, a perimeter tile water sample prior to the addition of manure to the structure.

B. Perimeter Tile Inspections:

1. Routine inspections of the perimeter tile outlets and inspection manholes should be done to ensure proper operations of the tile system. Follow your MPCA / County Livestock Permit requirements for the frequency of tile inspections and testing.
 - a. The tile should be inspected for traces of manure, high flows in a dry period, broken tile, and anything else unusual.
 - b. Records should be kept on the dates the tile was inspected, methods of inspection, and what was observed. If manure is observed in the tile, contact your local MPCA office immediately.

End of Operation and Maintenance Plan

STRUCTURAL NOTES

A. General:

1. Notes and details on the structural drawings take precedence over these structural notes.
2. The contractor shall verify all dimensions, elevations, and site conditions before starting work. The engineer shall be notified of any changes.
3. In no case shall dimensions be scaled from plans, sections, or details on the structural drawings.
4. All materials and workmanship shall conform to the requirements of the following codes:
 - a. International Building Code (IBC)
 - b. Minnesota State Building Code
 - c. American Concrete Institute (ACI)
 - d. Concrete Reinforcing Steel Institute (CRSI)
Manual of Standard Practice

B. Drain Tile:

1. The drain tile shall be heavy-duty perforated polyethylene tubing 4" diameter.
2. The tile shall be covered with a washed aggregate, up to the top of the footing elevation, as shown on the plans.
2. Connect the drain tile to an existing farm tile if available, discharge to surface drainage, or drain to a sump and pump to surface.

C. Temporary Bracing and Backfill:

1. Provide temporary lateral support for all walls where grade varies on the two sides until the permanent structural support system is in place.
3. Backfill only after the floor slats or solid floor has been installed.

D. Footings and Foundations:

1. Soil bearing design value: 2500 PSF (Assumed) on virgin soil or compacted fill for footings.
2. Protect foundation excavations from frost. Do not place concrete on frozen ground.
3. Foundation excavation shall be kept free of loose material and standing water.
4. Anchor bolts shall be $\frac{1}{2}$ " diameter with 7" embedment and 2 $\frac{3}{4}$ " projection.

E. Reinforced Concrete:

1. Concrete shall have a minimum 28-day compressive strength of $F'c = 4000$ psi.
2. Water cement ratio shall be 0.45 maximum.
3. Cement shall conform to ASTM C150, Type I.
4. Coarse aggregate shall be $\frac{3}{4}$ " Max.
5. Ready-mix concrete shall be mixed and delivered in accordance with ASTM C94.
6. Slump shall be a maximum of 6".
7. Air Content shall be between 4%-6%.
8. Concrete work shall conform to all the requirements of ACI 301.
9. Admixtures may be used with prior approval of the engineer for the purpose of increasing the workability but not to reduce the specified minimum cement content. Calcium chloride shall not be used.

F. Reinforcing Steel:

1. Bar reinforcement shall be ASTM A615, Grade 40 or 60.
2. Minimum lap splice or reinforcing bar, based on ACI 318, Class B, shall be as follows unless noted otherwise:
 - a. #3 Bars – 15"
 - b. #4 Bars – 20"
 - c. #5 Bars – 24"
 - d. #6 Bars – 30"
 - e. #7 Bars – 36"
 - f. #8 Bars – 42"

3. Reinforcing steel shall be provided with the following minimum cover unless noted otherwise:
 - a. Concrete placed against earth – 3”
 - b. Formed concrete exposed to earth or weather:
 - 1) #6 Bars through #8 Bars – 2”
 - 2) #5 Bars and smaller – 1 ½”
 - 3) Stirrups & Ties – 1 ½”
4. All reinforcing steel, anchor bolts, dowels, and inserts shall be secured in position with wire positioners, or equal, before placing concrete.
5. Dowels between footings and walls shall be the same grade, size, and spacing as vertical wall reinforcement.
6. All lap splices shall be tied at 3 locations.

G. Tolerances and Quality Control:

1. Column finish elevations shall be + or – ¼” from design elevation.
2. Wall alignment (horizontal) shall deviate no more than ¼” in 10 feet and no more than ¾” over the full length of the wall.
3. Wall bearing ledge elevations shall be + or – ¼” from design from design elevation in 10 feet and no more than ½” over the full length of the wall.
4. Overall foundation length and width dimensions and diagonal dimensions should be within ½” of plan dimensions.
5. Minor honeycombing shall be repaired on the same day that the forms are removed. Major honeycombing (greater than 1 ½” deep) shall be inspected by the engineer and repaired or removed at his direction.
6. Cracks which may extend through the concrete liner must be cleaned and sealed with MasterSeal NP1 Polyurethane Sealant, or approved equal. Larger cracks or defects may need an inspection by the engineer to determine the proper repair.
7. Test Cylinders: Take three (3) test cylinders for each 100 cubic yards of concrete placed but not less than three (3) test cylinders each day that 10 or more cubic yards are placed. Keep one of each three cylinders on the job and allow to field cure. Deliver two of the three cylinders to a licensed testing laboratory to be cured and tested at 7 days and 28 days.

H. Electrical Ground:

1. Install reinforcing bars as shown on the drawing. Verify Electrical Ground requirements with Electrical Contractor. Notify electrical inspector for inspection prior to placing concrete.

I. Cold Weather Concrete:

1. When, for more than 3 successive days, the mean daily temperature drops below 40 degrees Fahrenheit, the contractor shall place and protect the concrete in accordance with ACI 306.

J. Hot Weather Concreting:

1. When it is likely that temperatures between 75 degrees Fahrenheit and 100 degrees Fahrenheit will be approached or exceeded; that low relative humidity is present, or wind velocity will exceed 10 mph, the contractor shall place and protect the concrete in accordance with Chapter 4 & 5 of ACI 305.

K. Waterstops:

1. Waterstop can be 3/8" x 3/4" Bentonite/Butyl rubber, Equal to waterstop – RX, Ultrastop, Swellstop or a 4" ribbed with center bulb PVC Waterstop, Equal to Vinylex RCB -4316. Waterstops shall be placed in all construction joints on the floor and in the perimeter walls. Location and number of construction joints are to be determined by the contractor.

L. Fibermesh:

1. Fibermesh fibers shall be added to the concrete mix at a minimum rate of 2.0 pounds per cubic yard of concrete. The fibermesh shall be fibrillated polypropylene Olefin fibers, 3/4" in length.

CAST-IN-PLACE CONCRETE

This section includes specifications for formwork, reinforcement, accessories, cast-in-place concrete, finishing and curing.

A. Quality Assurance:

1. Construct and erect concrete formwork in accordance with ACI 301
2. Perform concrete reinforcing work in accordance with ACI Manual of Practice
3. Perform cast-in-place concrete work in accordance with ACI 318

B. Form Materials and Accessories:

1. Plywood: sound undamaged sheets with clean true edges
2. Lumber: grade as required
3. Prefabricated Steel Type: matched, tight fitting, stiffened to support weight of concrete
4. Pan Type: Steel of size and profile required
5. Tubular Column Type: Round, spirally wound laminated materials, inside surface treated with release agent, of size required
6. Form Ties: Snap-off, metal type of adjustable length
7. Form Release Agent: Colorless mineral oil which will not stain concrete or impair natural bonding characteristics of coating intended for use on concrete

C. Reinforcement Materials:

1. Reinforcing Steel: ASTM A615; deformed billet steel bars, plain finish.
2. Cement: ASTM C150, Normal-Type I Portland type.
3. Water: Clean and not detrimental to concrete.

4. Chairs, Bolsters, Bar Supports, Spacers: Sized and shaped for support of reinforcing.
5. Fabricate concrete reinforcing in accordance with ACI 318 and CRSI.

D. Compounds, Hardeners and Sealer:

1. Curing Compound: ASTM C309, Type 1, Class B type by:
Master Kure by Master Builders Technologies
Super Pliocure by Euclid Chemical Company
Dress and Seal #30 by L & M Construction Chemicals
2. Absorptive Mats: ASTM C171, Burlap-Polyethylene.

E. Concrete Mix:

1. Mix and deliver concrete in accordance with ASTM C94, Alternative 2.
2. Provide concrete of the following specifications:
3. Compressive strength 4000 psi 28 day (floors, walls, piers, and footings).
4. Slump shall be a maximum of 6 inches, 9" with the use of superplasticizers. Testing should follow ASTM C 143.
5. Maximum water/cement ratio: 0.45.
6. Concrete shall be placed according to ASTM C 94 on normal temperature days with an Air Content of 4.0% to 6.0%. Samples shall be obtained and tested in accordance with ASTM C 172.
7. Concrete temperature shall be tested according to ASTM C 1064. Concrete temperature during normal daytime temperatures shall be below 90 Deg. F.

F. Formwork Erection:

1. Erect formwork, shoring and bracing to achieve design requirements.
2. Camber slabs and framing to achieve ACI 301 tolerances.
3. Provide bracing to ensure stability of formwork.
4. Apply form release agent to formwork in accordance with manufacturer's

instructions, prior to placing for accessories and reinforcement.

5. Clean forms as erection proceeds, to remove foreign matter.

G. Inserts, Embedded Components and Openings:

1. Provide formed openings where required for work to be embedded in and passing through concrete members.
2. Coordinate work of other sections in forming and setting openings, slots, recesses, chases, sleeves, bolts, anchors, and other inserts.
3. Install concrete accessories straight, level, and plumb.
4. Install waterstops where shown on the plan and at all pit penetrations and cold joints.

H. Reinforcement Placement:

1. Place reinforcement, supported and secured against displacement.
2. Ensure reinforcing is clean, free of loose scale, dirt, or other foreign coatings.

I. Placing Concrete:

1. Place concrete continuously between predetermined expansion, control and construction joints. Screed floors, slabs-on-grade and concrete toppings level.

J. Form Removal:

1. Do not remove forms or bracing until concrete has gained sufficient strength to carry its own weight and imposed loads. Remove formwork progressively and in accordance with code requirements.

K. Finishing:

1. Uniformly spread, screed, and float concrete.
2. Maintain surface flatness, with maximum variation of 1/4 inch in 10 ft.

L. Curing:

1. Immediately after placement, protect concrete from premature drying.
2. Maintain concrete with minimal moisture loss at relatively constant temperature for period necessary for hydration of cement and hardening of concrete.

M. Concrete Testing:

1. A test of concrete shall include all of the following: Cylinders, Slump, Air Content and Temperature. Each test shall be taken once every 100 cubic yards of concrete placed and at least one test every day 10 or more cubic yards of concrete are placed. Additional testing is required to represent new mixes and different concrete suppliers.
2. Concrete cylinders:
 - a. Take three 3 test cylinders for 100 cubic yards of concrete placed but not less than three 3 test cylinders each day that 10 or more cubic yards are placed. Keep one of each three cylinders on the job site and allow to field cure. Within two days, deliver two of the three cylinders to a licensed testing laboratory to be cured and tested at seven 7 days and 28 days. Additional testing is required to represent new mixes and different concrete suppliers.
3. Concrete Rebound Hammer:
 - a. Rebound hammer tests may be taken after the pit is complete and at least 7 days after the last concrete was poured. Concrete shall be tested according to ASTM C 805.

N. Defective Concrete:

1. Modify or replace concrete not conforming to required lines, details, elevations or strength as directed by Engineer.
2. Cracks which may extend through the concrete liner must be cleaned and sealed with MasterSeal NP1 Polyurethane Sealant, or approved equal. Larger cracks or defects may need an inspection by the Engineer to determine the proper repair.
3. Honeycombing shall be patched with a sand/grout mix or commercial patching products such as TK-Complete Concrete Patch, Meadow-Patch 5 or approved equal.

COLD WEATHER CONCRETING

- A. Cold weather is defined as a period when for more than 3 successive days the mean daily temperature drops below 40°F. When temperatures above 50°F occur during more than half of any 24-hour period, the concrete should no longer be regarded as winter concrete. Cold weather concrete shall be placed, cured, and protected according to ACI 306 COLD WEATHER CONCRETING and these abbreviated specifications taken from ACI 306 COLD WEATHER CONCRETING.
- B. Plans to protect fresh concrete from freezing and to maintain temperatures above the designated minimum for the required time after placing should be made in advance of expected freezing temperatures. Preparation for cold weather concreting consists primarily in insuring that all surfaces to be in contact with newly placed concrete are at a temperature that cannot cause early freezing or seriously delay proper curing (hardening) of the concrete. Originally, the temperature of these contact surfaces, including sub-grade materials, need not be higher than a few degrees above freezing.
- C. In moderately cold weather, when heavy frost or freezing is forecast at the job site, all unformed concrete surfaces should be protected from freezing for at least 24-hrs after it is placed.
- D. During colder weather when mean daily temperatures are generally below 40°F, concrete shall be placed at a temperature not lower than:
1. 60°F when temperature is above 30°F.
 2. 65°F when temperature is 0°F to 30°F.
 3. 70°F when temperature is below 0°F.
 4. Maintain the placed concrete at a minimum temperature of 55°F for that time period indicated in E. below.
 5. Concrete should be placed at or near the lowest allowable temperature and not more than 10°F above the temperatures indicated above.

- E. **Air entrained concrete (5% to 7%) shall be used for cold weather concrete.** Footings and pit floor slabs shall be maintained at a minimum temperature of 55°F for 2 days following placement. Walls shall be maintained at a minimum temperature of 55°F for 3 days following placement.
- F. Heated enclosures, if used, must be strong, windproof, and weatherproof. Heating units should be vented and not permitted to heat or dry the concrete locally.
- G. Generally, the outline below should be followed:
1. Never place concrete on frozen ground or on snow or ice.
 2. Supply the concrete mix at a temperature in accordance with D. above but not less than 55°F.
 3. After placement of the concrete mix, keep the concrete at a temperature of 55°F for 2 days (floors and footings) and 3 days (walls) by the use of insulated blankets, straw, or the use of properly applied heat. Leave forms in-place during these days.
 4. Be particularly concerned with thin concrete, edges, and openings that will be exposed to wind or drafts.
 5. Have the necessary insulating material on site before placement of concrete when cold weather is likely to occur.

HOT WEATHER CONCRETING

Hot Weather is defined as any combination of high air temperature, low relative humidity, and wind velocity tending to impair the quality of fresh or hardened concrete or otherwise resulting in abnormal properties. When any of these conditions are present, the contractor shall place and protect the concrete in accordance with Chapter 4 of ACI 305 as described below:

4.1 General

4.1.1 The requirements for good results in hot weather concrete placing and curing is no different than in other seasons. The same necessities exist:

- a. That concrete be handled and transported with a minimum of segregation and slump loss.
- b. That concrete is placed where it is to remain.
- c. That the concrete be placed in layers shallow enough to assure vibration well into the layer below.
- d. That joints be made on sound, clean concrete.
- e. That finishing operations and their timing be guided only by the readiness of the concrete for them, and nothing else.
- f. That curing be conducted in such a manner that at no time during the prescribed period will the concrete lack ample moisture and temperature control, so that hydration continues to develop the full potential of strength and durability of the concrete.

4.2 Preparations for placing and curing

4.2.1 Preparations for placing and curing in hot weather include recognition at the start of work that certain abnormal conditions will exist which will require some items of preparation that cannot readily be provided the last minute before concrete is placed. If concrete temperatures as placed are expected to be abnormally high, preparation must be made to transport, place, consolidate, and finish the concrete at the fastest possible rate.

4.2.1.1 This means, first, delivery of concrete to the job must be scheduled so it will be placed promptly on arrival, particularly the first batch. Many concrete operations get off to a bad start because concrete was ordered before the job was ready and slump control was lost at this most critical time.

4.2.1.2 Equipment for placing the concrete must have adequate capacity to perform its functions efficiently so there will be no delays at distant portions of the work. There should be ample vibration equipment and manpower to consolidate the concrete quickly after placement and to maintain the rate of

placement in difficult areas. All equipment should be in first class operating condition. Breakdowns or delays that stop or slow the placement can seriously affect the quality of the work. Cold joints may be apparent when forms are removed; vibration failure can cause obvious lack of consolidation.

4.2.1.3 Due to more rapid slump loss in hot weather, the strain on vibrating equipment will be greater. Accordingly, provision should be made for an ample number of standby vibrators, at least one standby for each three vibrators in use. A concrete placing operation is in serious trouble, especially in hot weather, when vibration equipment fails and the standby equipment is inadequate. If possible, arrangements should be made in advance to secure another crane or pump quickly, in event of an equipment breakdown.

4.2.2 When there is to be flatwork on grade, early planning may make it feasible to plan a temporary windbreak or provide shade. In any event, the job should be equipped with ample water supply hose. The subgrade should be moist but free of standing water and soft spots at the time of concreting. Fogging can be used to cool and moisten surrounding air to prevent excessive evaporation from flatwork during finishing. Fog nozzles for this use should produce a fog blanket and they should not be confused with the common garden hose nozzles, which produce an excessive washing spray.

4.2.3 Preparation for placing includes proper location and preparation of construction joints. In hot weather, due to faster setting and hardening of the concrete, the timing of clean up by various methods, such as green cutting or surface retardant application, becomes more critical. Preparation must be made for prompt and adequate attention to these matters at the right time.

4.2.4 Work plans should include preparation to limit the temperature of concrete as placed. As the selected limiting temperature, usually but not always between 75 F (24C) and 100 F (38C) is approached and exceeded, it is increasingly likely that the unfavorable effects of high temperature will occur.

4.2.4.1 Whatever temperature limitation is considered worthwhile can be maintained to best advantage if mixers, belts, pump lines, and chutes are shaded. Where they cannot be shaded, they will absorb appreciably less heat from the sun if painted white and kept white. Pump lines and other surfaces can be kept appreciably cooler by covering them with damp burlap, kept damp with soil soaker hose. When daytime temperature and drying conditions may be critical, scheduling concrete placement to begin in the late afternoon will materially improve placing conditions. On massive slabs and pavements this has been found to result in much less thermal shrinkage and cracking. Concrete placed during the early morning may attain an undesirably high temperature, particularly during the middle of the day, when the maximum sun radiation and heat of hydration occur. Such concrete could subsequently be exposed to severe thermal stress on cooling.

4.2.5 Finally, preparation for placing concrete in hot weather includes the special provisions necessary for its hot proper protection and curing, since hot weather causes rapid drying. To avoid serious damage and cracking, facilities must be ready to protect promptly all exposed surfaces from drying. Water curing is much to be preferred for most concrete work, but it is recognized that prompt application of white-pigmented curing compound (ASTM C309) Type 2, is more practical for curing vast areas of flatwork on subgrade. Other alternatives for curing are described in ACI 308. Water curing must be continuous and the continuity of water curing is best assured if provision is made for covering all exposed surfaces, vertical, horizontal, and otherwise, with saturated material (burlap, cotton mats, old carpets, etc.) kept wet with soil soaker hose. This material should be kept in direct contact with the concrete surface at all times. Alternate cycles of wetting and drying promote the development of pattern cracking, and should be avoided. Curing water should not be much colder than the concrete because of temperature change stresses, which could be introduced with resultant cracking.

4.3 Placement and Finishing

4.3.1 Speed-up of placement and finishing materially reduces hot weather difficulties. Delays increase slump loss and invite the addition of water to offset it. Each operation in concrete finishing should be carried out promptly when the concrete is ready for it. It is necessary to make sure that concrete is not placed in the forms faster than it can be properly consolidated by men and equipment, or be properly finished by the men at hand. If the placing rate is not coordinated with available men and equipment, a job will soon be marked with cold joints, poor consolidation, and irregular surface finishes.

4.3.2 Regardless of the thickness of layers of concrete as placed under normal temperatures, each layer may have to be shallower in hot weather to assure coverage of the previous layer while it will still respond readily to vibration. The interval between monolithic wall and deck placements (to let the wall concrete develop its settlement shrinkage) becomes very short in hot weather, especially with warm concrete.

4.3.3 In placing beam and deck concrete, it is necessary in hot weather to keep the operation confined to a small area and to proceed on a front having a minimum amount of exposed surface to which concrete is to be added. A fog nozzle should be used generously to cool the air, to cool the forms and steel immediately ahead, and to lessen rapid evaporation from the concrete surface before and after each finishing operation. Excessive fog spraying (that which would wash the fresh concrete surface or cause water to stand on the surface during floating or troweling) must be avoided.

4.3.3.1 Without such fog spray between the finishing operations in hot weather, particularly if it is windy and humidity is low, water may be evaporated from the surface faster than it will rise naturally to the surface. This will create a growing tension in the surface, which often causes irregular, plastic-shrinkage cracking. Careful use of the fog spray previously mentioned, spreading and removing polyethylene sheeting between finishing operations, or application of monomolecular films after the strike-off, are recommended. Sometimes in relatively massive placement, revibration prior to floating will prevent the development of plastic-shrinkage cracking. When such cracking occurs prior to the final set, the cracks can be closed by striking the surface on each side of the crack with a float. It serves no lasting purpose to merely trowel slurry over them.

4.3.4 In summary, for best assurance of good results with concrete placing in hot weather, the initial concrete placement temperature should be limited to preferably between 75F (24C) and 100F (38C) as discussed in Sections 2.2.2 and 4.2.4. Every effort should be made to keep the concrete temperature uniform. All necessary precautions should be taken to see that concrete is promptly placed on arrival at the job and immediately vibrated after placement. Flatwork should be protected from excessive drying during finishing operations, and each operation should be performed without delay as soon as the concrete is ready for it. Under extreme conditions of high ambient temperature, exposure to direct rays of the sun, low relative humidity, and wind – perhaps aggravated by a slow rate of placement due to complexity of the structure in size and shape – careful and complete adherence to the foregoing practices may not produce the degree of quality desired for the work. Under such circumstances, it has been found worthwhile to restrict concrete placement to late afternoon or evening.

4.4 Curing and Protection

4.4.1 Curing and protection have been largely covered under Section 4.2. It should be emphasized that in hot weather there is great need for continuous curing, preferably by water. The need is greatest during the first few hours, and in fact throughout the first day after concrete is placed. All surfaces should be protected from drying, even intermittently, as this contributes to development of pattern cracking.

4.4.2 For water containment structures absorptive wood forms remaining in place should not be considered as a satisfactory means of curing in hot, drying weather. Forms should be covered and kept moist. The forms should be loosened, as soon as this can be done without damage to the concrete, and provisions made for the curing water to run down inside them. During form removal, care should be taken to provide wet cover to newly exposed surfaces to avoid exposure to hot sun and wind. Form tie cone holes can be filled and any necessary repairs made by uncovering a small portion at a time as necessary to carry on this work. These repairs should be completed in the first few days after stripping, so the repairs and

cone hole fillings can cure with the surrounding concrete. At the end of the prescribed curing period (7 days minimum; 10 is better), the coverage should be left in place without wetting for several (4 days suggested), so that the concrete surface will dry slowly and be less subject to surface shrinkage cracking. The effects of drying are further minimized by closing such structures as tunnels and pipelines against drafts and free circulation of drying air.

4.4.3 In summary, providing proper temperature and moisture conditions for curing of concrete are much more critical and important in hot weather than under normal temperatures. It is, therefore, of first importance that curing be promptly commenced, ample in coverage, and continued without interruption.

1
2
3
4
5
6
7
8
9
10
11
12
13
14
15
16
17
18
19
20
21
22
23
24
25
26
27
28
29
30
31
32
33
34
35
36
37
38
39
40
41
42
43
44
45
46
47
48
49
50
51
52
53
54
55
56
57
58
59
60
61
62
63
64
65
66
67
68
69
70
71
72
73
74
75
76
77
78
79
80
81
82
83
84
85
86
87
88
89
90
91
92
93
94
95
96
97
98
99
100