



Redwood County

www.co.redwood.mn.us

Animal Confinement Feedlot Conditional Use Permit Application

Permit #: 5-18 Date: 4-30-18

Proposed Location of Feedlot Operation:

Address: 29497 160th Street City: Lamberton State: MN Zip: 56152
House # Street Name

Parcel #: _____ Township: Willow Lake Section: 32 Twp #: T 110 N Range: R 36 W

Information about the Operation:

General description of feedlot operation (including type and number of animal units, barns, and manure storage plan):

3300 head swine barn (990 AU) with an 8' concrete pit for manure storage *13 month manure storage

Legal Description of Proposed Feedlot Location:

3.091 Acre parcel in SE 1/4 of SW 1/4 of section 32 of Willow Lake Township of Redwood County, MN

Site / Plan Information:

Zoning District: A6

Soil Type 1: clay - SEAFORTH LOAM 1 to 3 % slopes

Soil Type 2: clay - CANISTEO CLAY LOAM 0 to 2 % SLOPES

Water source for the site: NEW Well

Drainage System: PERIMETER TILE

Estimated water use:

Animal 1

Animal Type: Swine Finishing

0 gallons/day/animal x 3300 number of animals on site x 350 number of days present
185 = 982,000

Animal 2

Animal Type: _____

0 gallons/day/animal x 0 number of animals on site x 0 number of days present
 = 0 gallons/yr/site

Animal 3

Animal Type: _____

 gallons/day/animal x number of animals on site x number of days present
 = gallons/yr/site

Total Gallons: 0

Proposed Building(s) Information: (Please enter dimensions in feet)

Building 1: Width: 153' Length: 185'

Building 2: Width: Length:

Building 3: Width: Length:

Building 4: Width: Length:

Setback from road right-of-way: 200 : feet Setback from center line of road: 247.0 feet

Estimated date for beginning construction: _____ Estimated completion date: _____

General Contractor:

Name: _____ City: _____ State: MN

Applicant Information:

Note: If the applicant is not one natural person, requested information and signature(s) must be provided for each partner/associate/co-applicant and must include documentation of each co-applicant's legal identity and the legal relationship between them. Each partner/associate/co-applicant must sign or affirm the application before it will be accepted for consideration.

First Name: Jon Last Name: Schilling

Business Name: J+C Schilling Farms, LLC

Address: 223 North Jackson Ave City: Springfield State: MN Zip: 56087

Home Phone: — Cell Phone: 701-730-0831 Email: schilling.jon@gmail.com

List any additional applicants:

Land Owner: Complete only if different from Applicant

First Name: THOMAS Last Name: SCHILLING

Business Name: _____

Address: 16327 Co Hwy 17 City: Lamberton State: MN Zip: 56152

Home Phone: _____ Cell Phone: 507-327-8509 Email: tjschilling@gmail.com

If the applicant is not the owner of the land, please specify the type of agreement the applicant has with the owner of the land at the proposed site: Tom is the applicant's dad. The land will be deeded for construction.

Feedlot Operator: Complete only if different from Applicant

If the operator is not a natural person(s), you must also provide documentation of the operator's legal identity.

First Name: _____ Last Name: _____

Business Name: _____

Address: _____ City: _____ State: MN Zip: _____

Home Phone: _____ Cell Phone: _____ Email: _____

I affirm that the forgoing information is true and accurate. I understand that if any portion of this information is false or materially misleading, any conditional use permit issued in reliance upon this information is voidable at the election of Redwood County.

Applicant(s) Signature(s): Jon Schilling Date: 27 APR 2018

Landowner Signature: Thomas Schilling Date: 29 APR 2018

List of Required Documentation: (Application not complete until received)

- MPCA Application
- Manure Spreading Agreements
- Pit Design
- Manure Management Plan

Office Use Only * The section below is to be filled out by the Environmental Office Staff

Permit fee: \$700 Receipt #: 486939

Application Received: 4-30-18

Commission Action:	County Board Action:
Approved: _____ Date: _____	Approved: _____ Date: _____
Disapproved: _____ Date: _____	Disapproved: _____ Date: _____

Schilling Area Map

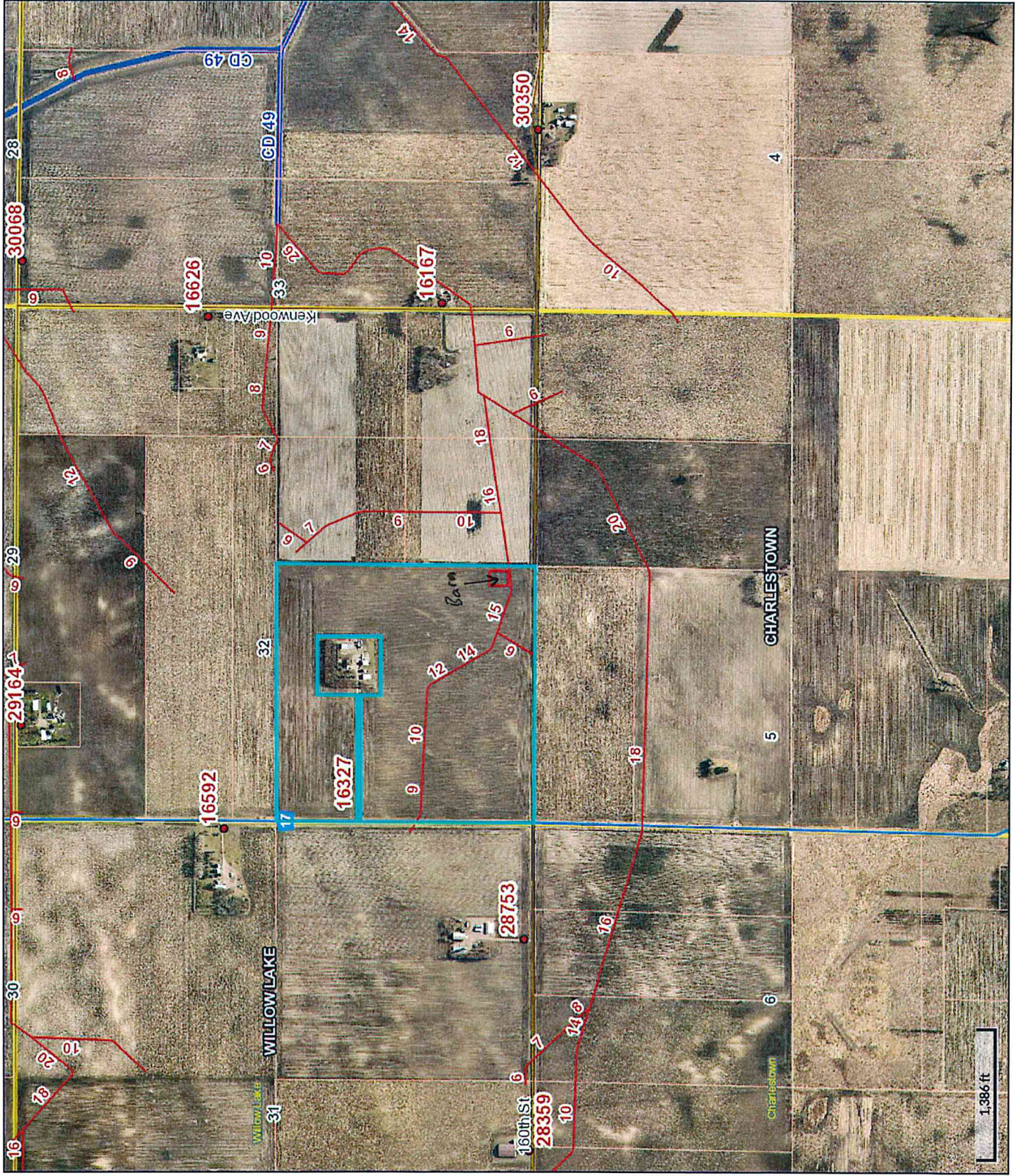

Legend

- Municipal Boundaries
- Sections
- Townships
- Open Ditch
- Drain Tile
- Address points
- Parcels
- Major Roads
- County/Twp/City
- State/Federal
- County
- Minor Roads

1,386 ft

SCHILING AREA MAP



11/28/2017 - 11/30/2017

SCHILLING ELEVATION MAP

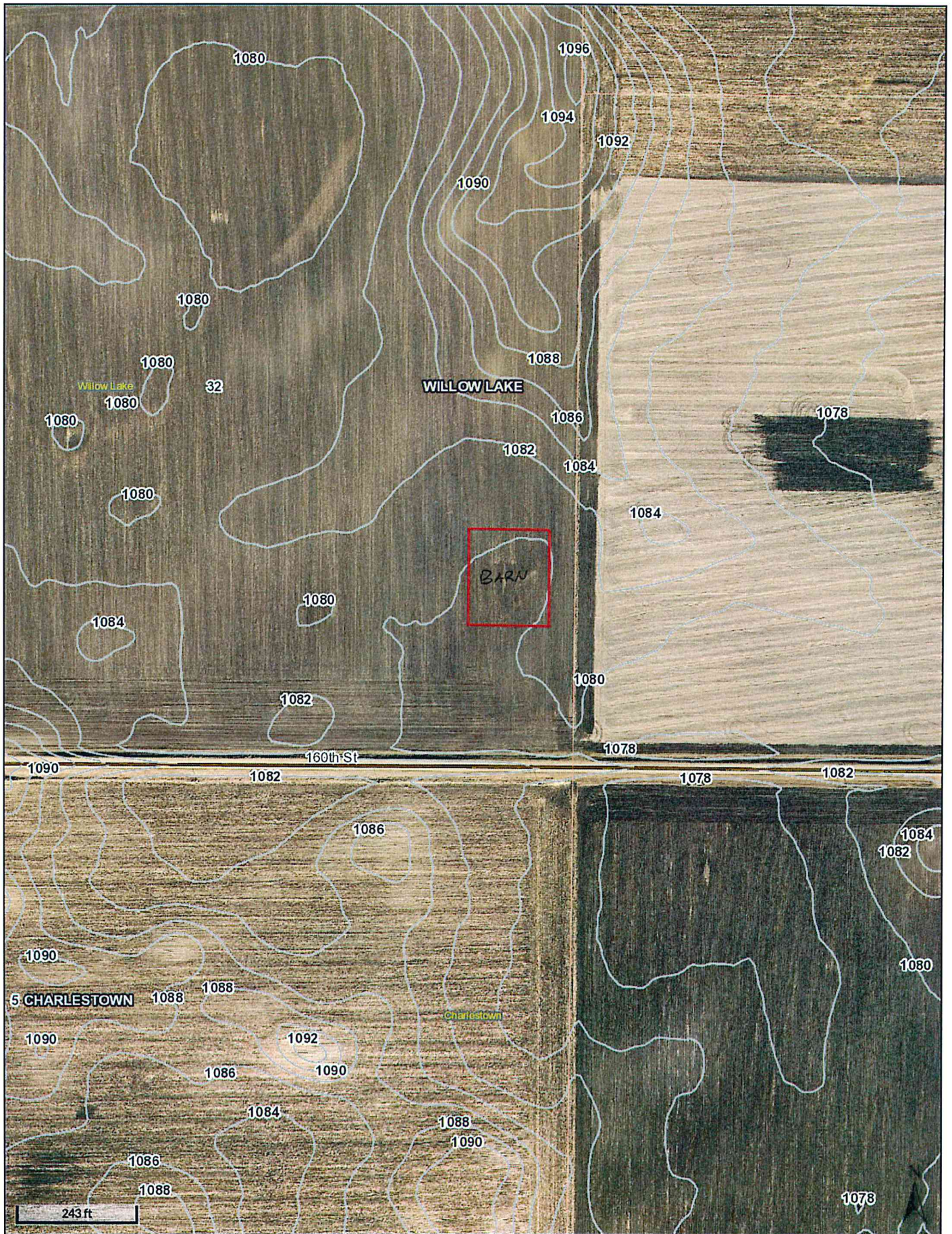

SCHILLING SOIL MAP



Animal feedlot or manure storage area permit application

NPDES and SDS Permit Program

Doc Type: Permit Application

Applicability: You must submit this form to the Minnesota Pollution Control Agency (MPCA) for issuance, reissuance, and major modification of National Pollutant Discharge Elimination System (NPDES) or State Disposal System (SDS) feedlot permit coverage. A separate application form exists for minor modification requests. *The Feedlot permit modifications fact sheet that explains major and minor permit modifications is available on the MPCA website at <https://www.pca.state.mn.us/feedlots> Keep a copy of this application form and all submittals for your records.*

Submit this form and any required enclosures to the MPCA as follows:

- After signing this form, scan and email it along with any required enclosures to FeedlotSubmittal.pca@state.mn.us.
 - To submit the application fee – mail the check with a copy of the first page of this form to the address listed below.
- If submission via email is not possible, you can mail this form, the required enclosures, and check for the application fee to:

Attn: Feedlot Master File Staff
Minnesota Pollution Control Agency
18 Wood Lake Drive SE
Rochester, MN 55904

I. Permit type and reason for application

Feedlot Registration number: _____

Please indicate which type of feedlot permit coverage you are applying for (*choose only one*)

- NPDES (Federal Permit) with State requirements included SDS (State Permit)

Please indicate the reason for the permit application (*choose only one*)

- General permit coverage issuance
(No existing general permit coverage or coverage under a new general permit due to pending expiration of current coverage)
- General permit coverage major modification
(Changes to sites with existing general permit coverage, including construction or expansion)
- Individual permit issuance
(No existing individual permit)
- Individual permit reissuance
(Existing Individual permit due to expire and no desire to make any changes)
- Individual permit major modification
(Changes to a site with an existing Individual permit, including construction or expansion)

II. Owner's name(s) and address(es) - (All partners of a Limited Liability Partnership (LLP) must be listed.)

Primary owner – Will be used as the mailing address

Additional owner – attach additional sheets as necessary

Name: J & C Schilling Farms, LLC

Name: Jon & Christa Schilling

Address: 223 North Jackson Ave

Address: 223 North Jackson Ave

City: Springfield

State: MN

City: Springfield

State: MN

Phone: 701-730-0831

Zip: 56087

Phone: 701-730-0831

Zip: 56087

Email: _____

Email: schilling.jon@gmail.com

Note: The term owner includes all persons having possession, control, or title to an animal feedlot or manure storage area (including lessees or renters). All owners must be listed. Attach to this application the names, addresses, and phone numbers of all additional owners.

III. Facility name and site address

Site Name: J & C Schilling Finisher

Facility is a MN Ag Water Quality Certified Farm (MAWQCP)

Complete if facility address is different than the primary owner address:

Street: 29497 - 160th Street

City: Lamberton

State: MN

Phone: _____

Zip: 56162

Contact person for day-to-day activities

Name: Jon Schilling

Street: _____

City: _____

State: _____

Phone: _____

Zip: _____

Cell phone: _____

Email: _____

(General letters/notices may be sent by email where one is indicated.)

IV. Billing address

Indicate where the Permit fee invoice(s) should be mailed (check only one):

- Primary owner address in Section II Contact person in Section III

V. Facility location

County: Redwood

Township name: Willow Lake

Township (26 – 71 or 101 – 168)	Range (1 – 51)	Section (1 – 36)	¼ Section (160 acre) (NW, NE, SW, SE)	¼ of ¼ Section (40 acre) (NW, NE, SW, SE)
T 110 N	R 36 W	32	SW	SE

VI. Sensitive features

- Is any part of the facility within 1,000 feet of any type of surface waters or tile intake? Yes No
If Yes, select all types below
 Lake River Stream (Perennial or Intermittent) Tile Intake
 Pond Creek Ditch Wetland Calcareous Fen Unknown
- Is any part of the facility located within 300 feet of a river/stream? Yes No
- Is any part of the facility located within a delineated flood plain (100 year flood)? Yes No
- Is any part of the facility located within designated shoreland? Yes No
- Is any part of the facility located within 1,000 feet of a karst feature? (sinkholes, caves, disappearing springs, resurgent springs, karst windows, dry valleys, or blind valleys) Yes No
If Yes, complete a. and b. below:
 - Are there 4 or more sinkholes within 1,000 feet? Yes No
 - Is any part of the facility within 300 feet of a known sinkhole? Yes No
- Is any part of the facility located within 1,000 feet of the following types of wells: Yes No
If Yes, select the applicable well type below:
 - a community water supply well
 - a well serving a public school as defined under Minn. Stat. § 120A.05
 - a well serving a private school excluding home school sites
 - a well serving a licensed child care center where the well is vulnerable (Minn. R. 4720.5550, subp. 2)

VII. Environmental Review (complete when construction or expansion is proposed)

Mandatory environmental review is required when the addition of 1,000 or more animal units (AU) is proposed as part of the construction/expansion at any facility. The threshold when environmental review is mandatory is reduced to 500 AU when any part of the facility is located within a "sensitive area". The facility is within a sensitive area when any of the following apply.

- Any part of the facility is within a delineated floodplain (yes to question 3 above)
- Any part of the facility is within designated shoreland (yes to question 4 above)
- Any part of the facility is within 1,000 feet of a karst feature (yes to question 5 above)
- Any part of the facility is within a vulnerable drinking water supply management area
- Any part of the facility is within a federal, state, or local wild and scenic river district
- Any part of the facility is located within the Minnesota River Project Riverbend area or the Mississippi headwaters area

Additionally mandatory environmental review is required for "Phased actions". Phased actions are defined under Minnesota law (Minn. R. ch. 4410) as two or more projects located in the same geographic area and constructed sequentially within three years of each other by the same proposer. When this is the case, the animal units from all projects are combined to determine if environmental review is required. The following will assist the MPCA to evaluate if your project qualifies as a "phased action".

Do you have ownership interest in another livestock operation that was constructed/expanded within the past three years or are you substantially certain you will be constructing/expanding another livestock operation within the next three years?

- Yes No

If Yes, how far away (straight-line distance) is it located from the project proposed in this application? _____ miles

There are also rule provisions to require completion of the environmental review process in the event of a citizen petition or upon the discretion of the MPCA. Please see the MPCA fact sheet entitled "[When is Environmental Review Required for Feedlots](#)" (available on the MPCA website at <https://www.pca.state.mn.us/quick-links/environmental-review>) and/or Minn. R. 4410 for further details.

VIII. Animal numbers and animal unit (AU) calculation

Complete the table below to identify the **maximum** number of animals housed at the facility. All animal numbers and animal sizes used to complete this table should reflect the animal holding **capacity** of the facility even if the facility does not currently house or propose to house that number of animals. At no time is the number of animals at the facility allowed to exceed the capacity provided below without first obtaining a permit or permit modification.

Current capacity - List the current head count **capacity** for each animal type in column 3 below. For sites with a permit, this should match the currently permitted number of animals. Next, multiply the AU Factor in column 2 by the number of animals listed in column 3 to get the **Current AU Capacity** for each animal type (column 4). Finally, add together all AU's in column 4 to get a total at the bottom of the chart. *If this application is for a brand-new feedlot site leave columns 3 and 4 blank. (i.e., bare piece of ground)*

Final capacity - List the final head count **capacity** for each animal type in column 5 below. This number should include current animals plus or minus any expansion or reduction in each animal type. This should reflect the maximum AU capacity requested with this permit application. Next, multiply the AU Factor in column 2 by the number of animals listed in column 5 to get the **Final AU Capacity** for each animal type (column 6). Finally, add together all AU's in column 6 to get a total at the bottom of the chart.

1. Animal type	2. Animal unit factor	Current AU capacity		Final AU capacity (Current +/- Changes)	
		3. Head count	4. Animal units = column 2 x column 3	5. Head count	6. Animal units = column 2 x column 5
A. Dairy cattle					
Mature cow (milked or dry) over 1,000 lbs.	1.4				
Mature cow (milked or dry) under 1,000 lbs.	1.0				
Heifer	0.7				
Calf	0.2				
B. Veal					
Veal	0.2				
C. Beef cattle					
Slaughter steer/heifer, stock cow, or bull	1.0				
Feeder cattle (stocker or backgrounding), heifer	0.7				
Cow and calf pair	1.2				
Calf (weaned)	0.2				
D. Swine					
Over 300 lbs.	0.4				
Between 55 and 300 lbs.	0.3			3300	990
Under 55 lbs.	0.05				
E. Horses					
Horse	1.0				
F. Sheep					
Sheep or Lamb	0.1				
G. Chickens with a liquid manure system					
Layer Hens or Broilers	0.033				
H. Chickens with a dry manure system					
Broilers over 5 lbs.	0.005				
Broilers under 5 lbs.	0.003				
Layer Hens over 5 lbs.	0.005				
Layer Hens under 5 lbs.	0.003				
I. Turkeys					
Over 5 lbs.	0.018				
Under 5 lbs.	0.005				
J. Ducks					
Duck (with a liquid manure handling system)	0.01				
Duck (with a dry manure handling system)	0.01				
K. Animals not listed in A to J (AU factor in column 2 = average weight of the animal type divided by 1,000 lbs.)					
Animal type:					
Total animal unit capacity					
Add all numbers in column 4 for Current AU total			Current AU Capacity Total		Final AU Capacity Total 990
Add all numbers in column 6 for Final AU total					

Pasture access: Do any animals at the facility have access to pasture? Yes No

IX. Animal holding areas

Complete the table below for all your animal holding areas. If needed, continue your list on an additional copy of this page.

Animal holding area ID

List each animal holding area in a separate column

Facility Site Sketch ID (i.e., #1, A, Barn 1)	1					
Status: (check one box only)	<input checked="" type="checkbox"/> Proposed	<input type="checkbox"/> Proposed	<input type="checkbox"/> Proposed	<input type="checkbox"/> Proposed	<input type="checkbox"/> Proposed	<input type="checkbox"/> Proposed
Proposed - not permitted previously	<input type="checkbox"/> Approved	<input type="checkbox"/> Approved	<input type="checkbox"/> Approved	<input type="checkbox"/> Approved	<input type="checkbox"/> Approved	<input type="checkbox"/> Approved
Approved - permitted but not yet operational	<input type="checkbox"/> Existing	<input type="checkbox"/> Existing	<input type="checkbox"/> Existing	<input type="checkbox"/> Existing	<input type="checkbox"/> Existing	<input type="checkbox"/> Existing
Existing - current operational component*	<input type="checkbox"/> Modifying	<input type="checkbox"/> Modifying	<input type="checkbox"/> Modifying	<input type="checkbox"/> Modifying	<input type="checkbox"/> Modifying	<input type="checkbox"/> Modifying
Modifying - change to a permitted component	<input type="checkbox"/> Eliminating	<input type="checkbox"/> Eliminating	<input type="checkbox"/> Eliminating	<input type="checkbox"/> Eliminating	<input type="checkbox"/> Eliminating	<input type="checkbox"/> Eliminating
Distance to nearest well (ft.)	110' +					

* for facilities without current NPDES or SDS permit coverage, this would include all current components of your registered feedlot

Type of animal holding areas

Write approximate dimensions in feet in the space below

(indicate dimensions and floor type)

(width x length or area with units for irregular shapes)

Total confinement barn (slatted floor)	153' x 185'					
Total confinement barn (solid floor)						
Partial confinement barn						
Open lot with runoff controls						
Open lot without runoff controls						
Animal Holding Area Floor Type (check all that apply)	<input checked="" type="checkbox"/> Concrete <input type="checkbox"/> Soil	<input type="checkbox"/> Concrete <input type="checkbox"/> Soil	<input type="checkbox"/> Concrete <input type="checkbox"/> Soil	<input type="checkbox"/> Concrete <input type="checkbox"/> Soil	<input type="checkbox"/> Concrete <input type="checkbox"/> Soil	<input type="checkbox"/> Concrete <input type="checkbox"/> Soil
	<input type="checkbox"/> Asphalt <input type="checkbox"/> Other	<input type="checkbox"/> Asphalt <input type="checkbox"/> Other	<input type="checkbox"/> Asphalt <input type="checkbox"/> Other	<input type="checkbox"/> Asphalt <input type="checkbox"/> Other	<input type="checkbox"/> Asphalt <input type="checkbox"/> Other	<input type="checkbox"/> Asphalt <input type="checkbox"/> Other

Animal numbers

Indicate the maximum capacity (number of animals) of each animal holding area

The total number of all animals listed should match the final animal numbers listed on page 3.

Mature dairy cows (over 1,000 lbs.)						
Mature dairy cows (under 1,000 lbs.)						
Dairy heifers						
Dairy calves						
Veal						
Slaughter steer/heifer, stock cow or bull						
Feeder cattle-stocker/background/heifer						
Cow and calf pair						
Beef calves (weaned)						
Swine over 300 lbs.						
Swine between 55 and 300 lbs.	3300					
Swine under 55 lbs.						
Horses						
Sheep or lamb						
All chickens with liquid manure system						
Broiler chickens over 5 lbs. - dry system						
Broiler chickens under 5 lbs. - dry system						
Laying hens over 5 lbs. - dry system						
Laying hens under 5 lbs. - dry system						
Turkeys - over 5 lbs.						
Turkeys - under 5 lbs.						
Ducks						
Other:						

Air emissions plan for animal holding areas*

Indicate from the list below the letter(s) of the applicable air emission control strategy(s)

(choose at least one strategy for each category below for each animal holding area)

Odor control strategies currently employed	C,D,E,G					
Possible additional odor control strategies** (must indicate at least one practice)	J					

Potential practices employed to minimize emissions/odors from animal holding areas

- | | |
|---|---|
| A. Disperse/mix air with tree plantings | F. Higher oil and fat content in feed to reduce dust |
| B. Treatment of escaping air with control technologies | G. Eliminate manure buildup under gates, feeders, etc.. |
| C. Maintain clean, dry floors to eliminate manure buildup | H. Maintain exhaust fans and avoid manure and dust accumulation |
| D. Promptly clean up any spilled feed | I. Use spray oil to reduce dust |
| E. Regular removal of manure | J. I will consult the MPCA to identify changes that can be made to reduce odors |
| K. Other: _____ | |

* This satisfies Minn. R. 7020.0505, subp. 4 item B (1). The response to documented exceedances is satisfied by the application certification text.

** In the event that odor complaints are validated, the practices identified will be implemented pursuant to MPCA request/approval.

X. Manure handling, feed storage, and dead animal areas

Complete the table below for your manure storage, feed/silage storage areas and dead animal disposal areas on your site. If needed, continue your list on an additional copy of this page.

Manure, feed, or dead animal areas	List each manure handling, feed storage, and dead animal area in a separate column					
Facility Site Sketch ID (i.e., #1, A, Basin 1)	1	2				
Status: (check one box only) Proposed - not permitted previously Approved - permitted but not yet operational Existing - current operational component* Modifying - change to a permitted component	<input checked="" type="checkbox"/> Proposed <input type="checkbox"/> Approved <input type="checkbox"/> Existing <input type="checkbox"/> Modifying <input type="checkbox"/> Eliminating	<input checked="" type="checkbox"/> Proposed <input type="checkbox"/> Approved <input type="checkbox"/> Existing <input type="checkbox"/> Modifying <input type="checkbox"/> Eliminating	<input type="checkbox"/> Proposed <input type="checkbox"/> Approved <input type="checkbox"/> Existing <input type="checkbox"/> Modifying <input type="checkbox"/> Eliminating	<input type="checkbox"/> Proposed <input type="checkbox"/> Approved <input type="checkbox"/> Existing <input type="checkbox"/> Modifying <input type="checkbox"/> Eliminating	<input type="checkbox"/> Proposed <input type="checkbox"/> Approved <input type="checkbox"/> Existing <input type="checkbox"/> Modifying <input type="checkbox"/> Eliminating	<input type="checkbox"/> Proposed <input type="checkbox"/> Approved <input type="checkbox"/> Existing <input type="checkbox"/> Modifying <input type="checkbox"/> Eliminating
Distance to nearest well (ft.)	110' +	75' +				

* for facilities without current NPDES or SDS permit coverage, this would include all current components of your registered feedlot

Type of liquid manure or process wastewater storage/treatment areas (indicate dimensions)	Write approximate top dimensions in feet in the space below (width x length x depth or volume with units for irregular shapes)					
Earthen or GCL lined basin						
Below barn concrete tank	153' x 185' x 8'					
In-ground concrete tank/basin (outdoor)						
Above-ground concrete tank						
Synthetic lined (HDPE, EPDM, etc.) basin						
Steel tank (i.e., slurry-store)						
Composite lined (2 liner types) basin/tank						
Vegetated Infiltration Area						
Other (describe):						

Type of solid manure, feed storage, and dead animal areas (indicate dimensions and floor type)	Write approximate dimensions in feet in the space below (width x length or area with units for irregular shapes)					
Permanent stockpile						
Dead animal management area		10' x 10'				
Covered feed storage area	Bulk Bins					
Uncovered feed storage area						
Sweet corn silage storage storage pad area						
Tonnage on site at any one time						
Other (describe):						
Stockpile, feed storage, or mortality area floor/liner type (check all that apply)	<input checked="" type="checkbox"/> Concrete <input type="checkbox"/> Soil <input type="checkbox"/> Asphalt <input type="checkbox"/> Other	<input checked="" type="checkbox"/> Concrete <input type="checkbox"/> Soil <input type="checkbox"/> Asphalt <input type="checkbox"/> Other	<input type="checkbox"/> Concrete <input type="checkbox"/> Soil <input type="checkbox"/> Asphalt <input type="checkbox"/> Other	<input type="checkbox"/> Concrete <input type="checkbox"/> Soil <input type="checkbox"/> Asphalt <input type="checkbox"/> Other	<input type="checkbox"/> Concrete <input type="checkbox"/> Soil <input type="checkbox"/> Asphalt <input type="checkbox"/> Other	<input type="checkbox"/> Concrete <input type="checkbox"/> Soil <input type="checkbox"/> Asphalt <input type="checkbox"/> Other

Air emissions plan for liquid and solid manure storage areas* (choose at least one strategy for each category below for each manure storage area) (this is not required for feed storage areas, vegetative infiltration areas, or dead animal management areas)	Indicate from the list below the letter(s) of the applicable air emission control strategy(s)					
Odor control strategies currently employed	P					
Possible additional odor control strategies** (must indicate at least one practice)	O					

Potential practices employed to minimize emissions/odors from manure storage areas (no practices required for feed storage areas, vegetative infiltration areas, or dead animal management areas)	
Liquid storage area specific (basins, pits, etc.)	Practices applicable to solid or liquid storage areas
A. Maintain crust on basin by using organic bedding	K. Notify neighbors of manure application periods and avoid holidays
B. Cover liquid manure storage area with straw	L. Disperse/mix air with tree plantings
C. Cover liquid manure storage area with synthetic cover	M. Add straw or other bedding material to reduce odor/ emissions
D. Anaerobic digestion	N. Treatment of escaping air with control technologies
E. Separate solids with settling basin or liquid/solid separator	O. I will consult the MPCA to identify changes that can be made to reduce odors
F. Utilize a pit additive to break down solids	
G. Reduce length of time stockpile is maintained	P. Other: <u>Minimize excess protein in diets, to minimize excess nitrogen in manure</u>
H. Solid manure composting	Q. Other: _____
I. Cover the solid manure stockpile	R. Other: _____
J. Incinerate solid manure at approved/permitted facility	

* This satisfies Minn. R.7020.0505 subp. 4 item B (1). The response to documented exceedances is satisfied by the application certification text.

** In the event that odor complaints are validated, the practices identified will be implemented pursuant to MPCA request/approval.

XI. Changes to groundwater monitoring plan (complete only if applicable)

If groundwater monitoring is required at the facility, this application can request changes to the MPCA-approved groundwater monitoring plan. In order to request changes to the groundwater monitoring plan, please indicate the type of change requested.

- Elimination of monitoring Change to sampling frequency
 Change to sample testing protocol Other

When a change is requested, please include with this permit application documentation from a qualified professional that provides a technical analysis and justification for the requested changes.

XII. Notifications and public meetings

The notifications identified in items A and B are required to be done **before** permit issuance.

A. 500 or more AU: Notice to residents and property owners within 5,000 feet of a proposed project

When required. A notice is required in *either* of the following situations:

- **Construction of a new** feedlot, or manure storage area, which will have a capacity of 500 AU or more.
- **Expansion of an existing** feedlot, or manure storage area, which currently has, or will have upon completion of the expansion, a capacity of 500 AU or more.

Notice methods. The owner shall not less than 20 business days before the anticipated issuance date of the permit, provide notice to each resident and each owner of real property within 5,000 feet of the perimeter of the proposed facility. This notice *must* include, at a minimum, the information provided in Minn. R. 7020.2000, subp.4.

An example notice can be found in the factsheet [Public Notification Requirements – Feedlots with more than 500 Animal Units](https://www.pca.state.mn.us/feedlots) available on the MPCA website at <https://www.pca.state.mn.us/feedlots>.

Verification of notice.

The MPCA must verify that this notice has been completed prior to permit issuance. Documentation that this notice has been completed can be provided with the permit application (preferred) or submitted at a later date, prior to permit issuance.

When the notice has been completed prior to this application

Please include with this permit application one of the following options that provides verification that the required notice has been completed:

- An affidavit of publication from a newspaper of general circulation used to provide this notification.
- A list of all parties, with their location, that were notified by certified mail and copies of all signed mail return receipts.
- A list of all parties, with their location, that were personally visited with a date and signature from each party and certification signed by a notary public indicating in detail what was discussed.

When the notice has not been completed prior to this application

Please include with this permit application the following:

- A copy of the content of the notification
- Date notification is scheduled to occur: _____

Note: The permit cannot be issued prior to receiving verification that the notice has actually taken place. This verification must be one of the three items listed above.

B. Non-delegated county public meeting minutes (Minn. Stat. § 116.07, subd. 7(l))

A county which has not accepted delegation of the feedlot program must hold a public meeting prior to issuance of a feedlot permit by the MPCA for an animal feedlot with a capacity of 300 or more animal units.

Date meeting has occurred or is scheduled to occur: _____

Verification of public meeting.

A copy of the meeting minutes must be provided to the MPCA for verification of completion of this requirement prior to permit issuance.

XIII. Certification and signature

General permit

The Applicant certifies that, if this is an application is for a general permit, they are familiar with the requirements of the general permit. The Applicant understands that if the MPCA determines the facility does not meet the criteria for coverage under the general permit; this application will be used as an application for an individual Permit.

Notification to local officials

The Applicant certifies that, if the application includes construction of a new facility or expansion of an existing facility, all local zoning authorities have been notified in accordance with Minn. R. 7020.2000 subp. 5.

Operation and Maintenance Plan

The Applicant certifies that the following operation and maintenance measures will be employed:

- Operate and maintain manure storage areas according to the approved design plans including:
 - Repair of damage
 - Maintenance of freeboard
 - No discharge (unless approved)
 - Control vegetation and tree growth with frequent mowing
 - Access only at designated points (i.e. concrete ramps)
- Divert surface water flow away from and prevent pooling near manure storage areas
- Operate manure storage area capacity to be consistent with the approved manure management plan
- Perform routine maintenance of manure handling/transfer equipment
- Minimize erosion and sediment transport with vegetative buffers and/or gravel/rock energy dissipation
- Minimize stormwater contact with sources of pollution
- Operate animal mortality management areas according to MN Board of Animal Health and other applicable requirements
- Dispose of solid and hazardous waste according to applicable regulations
- Perform groundwater monitoring according to the MPCA approved plan

Air Emissions Plan – response to documented exceedances (Minn. R. 7020.0505 subp. 4, item B (1)(b))

The Applicant certifies that, if ambient air quality monitoring indicates an exceedance of the Hydrogen Sulfide Standard, they will submit a report, at the MPCA's request, that provides documentation that one of the following will control the emissions.

Liquid manure storage areas

- Chemical additions
- Natural crusting
- Straw cover
- Synthetic cover (i.e., HDPE)
- Treatment of escaping air

Solid manure storage areas

- Synthetic cover
- Frequent manure removal
- Frequent land application
- Incineration
- Composting

The report will provide evidence that the technology will control the emissions, indicate when the technology will be installed and fully operational, and indicate what temporary measures will be taken to minimize emissions prior to installation. Alternatives may be approved at the discretion of the MPCA. The report will be immediately implemented upon MPCA approval.

Construction Stormwater (CSW) Permit

The Applicant certifies that, if this application is for a NPDES permit where construction activities will disturb one or more acres of land, it will also serve as an application for the general CSW NPDES permit, as referenced in the feedlot NPDES permit, unless a separate application for CSW NPDES permit coverage has been made. The Applicant agrees to comply with the requirements of the CSW NPDES permit.

Applicant signature

I hereby certify that the design, construction, and operation of the facility will be in accordance with this application and plans, specifications, reports, and related communications approved by the MPCA, and in accordance with applicable permit conditions or regulations/standards of the MPCA.

I also certify under penalty of law that this document and all attachments were prepared under my direction or supervision and the information submitted is, to the best of my knowledge and belief, true, accurate, and complete. I am aware that there are significant penalties for submitting false information, including the possibility of fine and imprisonment for knowing violations.

The person that signs this application must be one of the following:

- A. For a corporation, a principal executive officer of at least the level of vice president
- B. For a partnership, a general partner
- C. For a sole proprietorship, the proprietor

Print name: J & C Schilling Farms, LLC by Jon Schilling Print official title: Owner

Office phone: _____ Cell phone: 701-730-0831

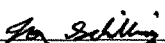
Signature:  Date: 4-22-18

To sign up for electronic communications including reminders for annual reports as well as MPCA feedlot newsletters and other MPCA communications, please go to the MPCA website at <https://public.govdelivery.com/accounts/MNPCA/subscriber/new>.

Required enclosures (Permit applications submitted without all required enclosures are incomplete.)

All forms are available on the [NPDES and SDS permits](https://www.pca.state.mn.us/feedlots) page of the MPCA feedlot program website at: <https://www.pca.state.mn.us/feedlots>

- A. A site sketch/aerial photograph indicating the location of the existing and proposed facility components.
- B. A Manure/Nutrient Management Plan (MMP) **submitted on the MPCA’s standardized form.**

When **all** manure is transferred to another entity for utilization, complete a MMP using the form:

[MMP requirements when ownership of manure is transferred.](#)

When **any** portion of manure is applied to land owned, rented, or leased by the applicant(s), or applied to other land where nutrient application decisions are made by the applicant(s), complete a MMP using the spreadsheet form:

[MPCA Manure Management Planner.](#)

Notes: The MMP requirements when ownership of manure is transferred form is incorporated into the spreadsheet to account for instances when only some of the manure is transferred.

A hand-entry version of the [MPCA Manure Management Planner.](#)

- C. Plans and Specifications for construction, modification, or expansion of any liquid manure storage area.
- D. [Emergency Response Plan](#) for response to manure spills and catastrophic animal mortality events. The plan must be completed using the MPCA's form.
- E. Permit application fee: (**Check payable to:** Minnesota Pollution Control Agency)

Permitting action	Application fee	Application fee when Environmental Review (EAW) is required*
General permit coverage issuance	\$620	\$5,270
General permit coverage major modification	\$620	\$5,270
Individual permit issuance	\$1,860	\$6,510
Individual permit reissuance	\$620	\$5,270
Individual permit major modification	\$1,860	\$6,510

*See Part VII of this application for more information regarding the need for preparation of an EAW.

- F. **Conditional** – Stormwater Pollution Prevention Plan (SWPPP). Development of a SWPPP is required when construction disturbs one or more acres at any feedlot site. The SWPPP must be available at the construction site but does **not** need to be submitted with this application unless the construction disturbs 50 acres or more of land and this application is for an NPDES permit.

The MPCA has developed the [SWPPP template for feedlot construction activities](#) to assist in development of a SWPPP.

- G. **Optional** – Verification of the notifications required in part XII of this application. If not submitted with the application, the MPCA must receive the verification prior to permit issuance. It is strongly recommended that the applicable verifications be included with the permit application.



Minnesota Pollution Control Agency

520 Lafayette Road North
St. Paul, MN 55155-4194

Emergency Response Plan

NPDES and SDS Permit Program

Feedlot Program

Doc Type: Permit Application

Applicability: This *Emergency Response Plan* is to be used in case of an emergency spill, leak, or failure at the production facility or land application area and to assist with response to catastrophic animal mortality events (barn fires, tornadoes, etc.). You must submit this form as part of an application for National Pollutant Discharge Elimination System (NPDES) or State Disposal System (SDS) feedlot permit coverage.

Facility name: J & C Schilling Farms, LLC Finisher in Willow Lake 32 Feedlot registration no.: _____
Owner/Operator name: Jon & Christa Schilling Feedlot permit no.: _____

List of critical phone numbers and contacts

	Contact person (or Company)	Phone number		
Emergency contacts				
• Fire/Ambulance	-----	911		
• County Sheriff	Redwood County	507-637-4036		
Agency contacts				
• Minnesota Duty Officer	-----	1-800-422-0798	Provide the Minnesota Duty Officer:	
• Minnesota Pollution Control Agency (MPCA) Field Office	Marshall Office	507-537-7146		
• County Feedlot Officer (CFO)	Redwood County	507-637-4023		
• Board of Animal Health Contact	St Paul Office	651-296-2942		
Other contacts				
• Insurance company			<ul style="list-style-type: none"> • Your contact information • Incident location, date, and time • For spills <ul style="list-style-type: none"> - spill type - spill amount - surface water or field tile impacted • Progress made in response to the spill or catastrophic mortality event 	
• Gopher State One Call	-----	1-800-252-1166		
•				
Local vendors for spill and/or catastrophic mortality response assistance				
• Manure pumper	Jeremy Loose	507-752-7248		
• Manure loading equipment	Jeremy Loose	507-752-7248		
• Earth moving equipment	Tom Schilling	507-327-8509		
• Tiling equipment	Tom Schilling	507-327-8509		
• Containment/Absorption materials (hay, straw, cornstalks, sawdust)	L & S Construction	507-648-3382		
• Mortalities	Central By-Products	844-637-2938		

Manure Spill Emergency Response Procedures*

- Immediately stop the source of a liquid manure leak or spill:
 - Turn off pumps or valves
 - Clamp hoses or park tractor on hoses
- Contain spilled manure:
 - Use skid loader or tractor with blade to make berms
 - Install bale checks and block downstream culverts
 - Insert sleeves around tile intakes (or plug/cap)
 - Use tillage equipment to work ground ahead of spill
 - Use absorptive materials
- Make necessary phone calls as listed in the chart above:
 - Notify Minnesota Duty Officer at 1-800-422-0798
 - Notify sheriff's office if spilled on public roads or right-of-ways
- Cleanup:
 - Clean up spill immediately from road and roadside
 - Clean up all material, including the contaminated soil, as soon as possible by scraping, or by other means
 - Land apply manure at agronomic rates or place manure back in the manure storage area/ solid manure stockpile
 - Follow recommendations of MPCA staff and/or CFO
 - Restore site to its original conditions
 - If rain is expected prior to completion of cleanup; actions need to be taken to contain manure contaminated runoff from solid manure spills
- Document your actions:
 - Keep records of all actions related to the spill and follow up activities

*A detailed site map should be displayed on site to assist employees identify sensitive receptors near the facility (surface water, wells, tile intakes, etc.).

Catastrophic Animal Mortality Response

- Make necessary phone calls as listed in the chart above:
 - Notify Minnesota Duty Officer at 1-800-422-0798
 - Notify Minnesota Board of Animal Health
 - Notify MPCA and CFO
 - Cleanup
 - Dispose of mortalities according to recommendations of MN Board of Animal Health Representative
 - Locate disposal area for mortalities to prevent impacts to surface and/or groundwater (consult MPCA/CFO)
 - Document your actions
 - Keep records of all actions related to the animal mortality disposal activities
- If burial of animal mortalities is necessary, the burial site must meet the following:
- Located 1000 feet from lakes and 300 feet from rivers and streams
 - Mortalities are not buried within 5 feet of the seasonal water table
 - Mortalities are not buried within 10 feet of karst susceptible bedrock
 - Soils are not sandy or gravelly
- Describe approximate location(s) of potential burial site(s) below:
- Rendering

Certificate of Survey

A part of the Southeast Quarter of the Southwest Quarter
in Section 32-110-36, Redwood County, Minnesota.

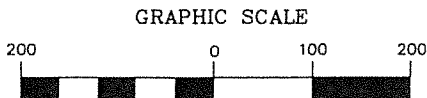

(IN FEET)
1 inch = 200 feet

LEGEND

These standard symbols will be found in the drawing.

- MONUMENTS FOUND
- MONUMENTS SET- 5/8" IRON
W/SEAL #43844



BROKEN SCALE

SW COR SW1/4
SEC 32-110-36
RAILROAD SPIKE

APPROXIMATE
EAST LINE SW1/4

S 89°35'59" E
263'±

N 00°28'11" E 512.00'

AREA = 3.1± ACRES

SOUTHERLY 512'±

SE COR SW1/4
SEC 32-110-36
5/8" IRON
W/SEAL #23008

SOUTH LINE SW1/4
2638.74'

263.00'
N 89°35'59" W

LAND DESCRIPTION

All that part of the Southeast Quarter of the Southwest Quarter of Section 32, Township 110 North, Range 36 West, Redwood County, Minnesota, being more particularly described as follows:

Beginning at the southeast corner of said Southwest Quarter; thence North 89 degrees 35 minutes 59 seconds West, bearing based on Redwood County Coordinate System (1996 Adj.), along the south line of said Southwest Quarter, a distance of 263.00 feet; thence North 00 degrees 28 minutes 11 seconds East a distance of 512.00 feet; thence South 89 degrees 35 minutes 59 seconds East a distance of 263 feet, more or less, to a point on the east line of said Southwest Quarter; thence southerly, along said east line, a distance of 512 feet, more or less, to the point of beginning.

Said tract is subject to any existing highways, roadways, or easements.

SURVEYOR'S CERTIFICATION

I hereby certify that this plan, specification, or report was prepared by me or under my direct supervision and that I am a duly Licensed Land Surveyor under the laws of the State of Minnesota.

DANIEL L. BUELTEL LICENSE NO: 43844

DATE: MARCH 26, 2018

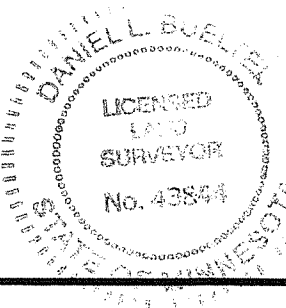

Prepared for Tom Schilling

Prepared by
Bueltel-Moseng Land Surveying, Inc.
Marshall, MN 56258 Ph. 507-532-9043
PROJECT NO. 18-5338

TABLE OF CONTENTS

SHEET 1 -	COVER PAGE
SHEET 2 -	SITE PLAN
SHEET 3 -	PIT PLAN
SHEET 4 -	SIDEWALL END WALL BRACING & BEAM POCKET COLUMN DETAIL
SHEET 5 -	PUMP OUT NOTES PUMP OUT SECTION
SHEET 6 -	CURTAIN END PUMPOUT FAN END PUMPOUT TYPICAL BARN PUMPOUT BEAM DETAIL
SHEET 7 -	CONSTRUCTION JOINTS CORNER REBAR PERIMETER TILE PERIMETER TILE SUMP PERIMETER TILE SYSTEM NOTE 12" DIVIDER WALL INSPECTION RISER DETAIL
SHEET 8 -	CONCRETE & STRUCTURAL NOTES SLAT LEDGES & STEM WALLS NOTE

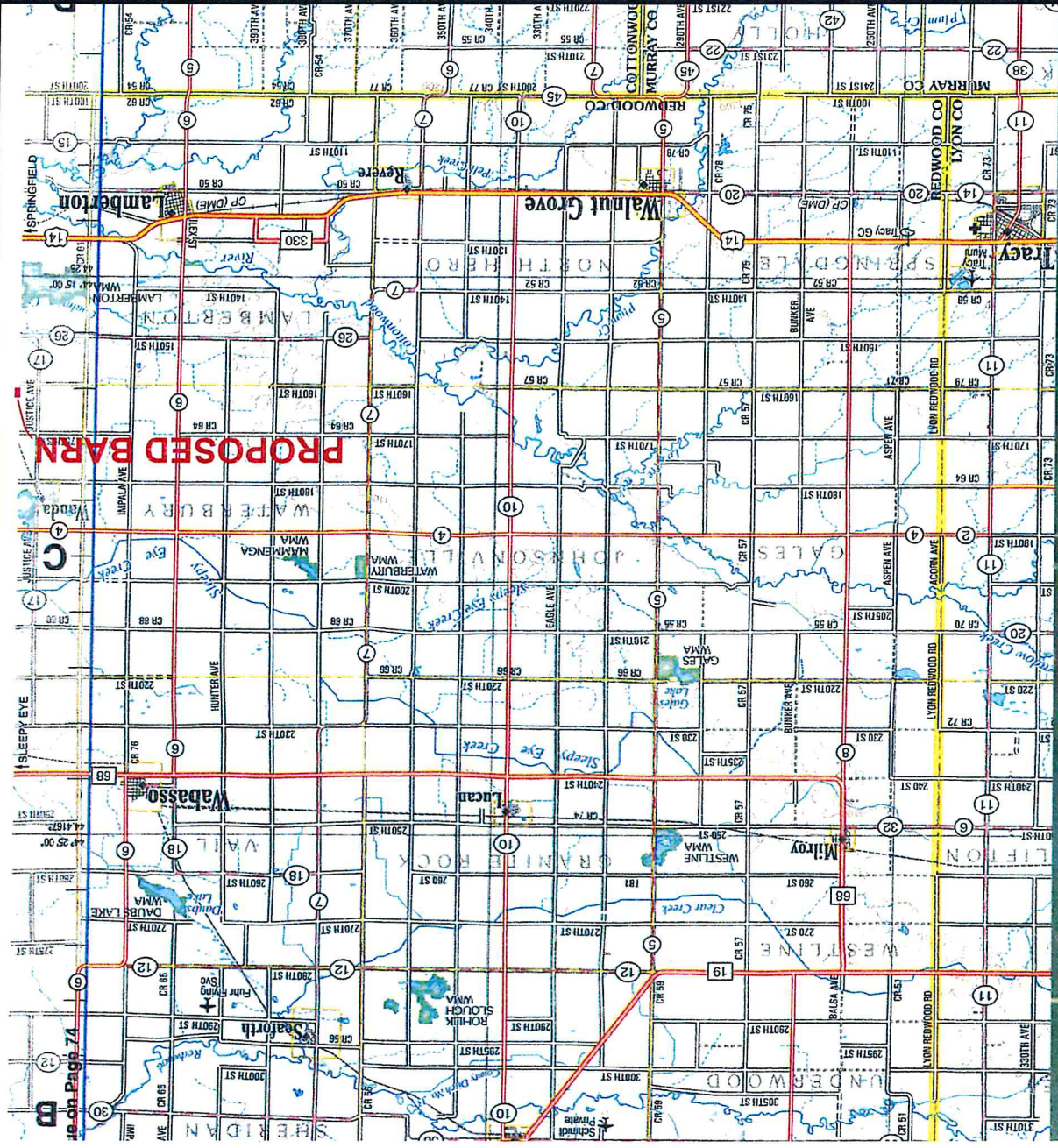

ProAs Engineering, Inc.
77402 Highway 71, P.O. Box 181
Jackson, MN 56143
(507) 849-7200

TOM SCHILLING
PROPOSED SWINE CONFINEMENT BARN
SW 1/4, SECTION 32, T110N, R36W
REDWOOD COUNTY, MINNESOTA

SHEET 1/8	Project No.	18-012
	Checked By	N.J.R.
Date	2/22/18	Drawn
	D.D.A.	

I hereby certify that this engineering document was prepared by me or under my direct personal supervision and that I am a duly licensed Professional Engineer under the laws of the State of Minnesota.
Nicholas J. Rowe
Date *2/22/18*
Nicholas J. Rowe, P.E.
License number 46735
My license renewal date is June 30, 2018
Pages or sheets covered by this seal: *Sheet 1-8*

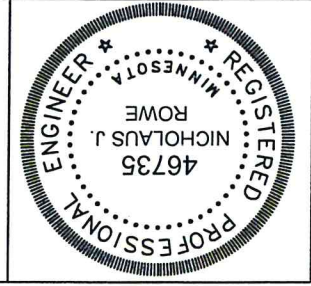

PROPOSED CONSTRUCTION WILL DISTURB LESS THAN 3 ACRES AND WILL CREATE LESS THAN 1 ACRE OF IMPERVIOUS AREA (BARN 28,390 S.F. + DRIVEWAY 14,592 S.F. = 42,982 S.F.) NO STORM WATER PERMIT IS REQUIRED BUT A STORMWATER POLLUTION PREVENTION PLAN (SWPPP) HAS BEEN DEVELOPED USING CONSTRUCTION BEST MANAGEMENT PRACTICES

PROPOSED DESIGN VOLUMES
 1.) 3300 HEAD FINISHING SWINE = 0.14 C.F./HEAD/DAY @ 365 DAYS = 168,630 C.F.
 2.) PIT VOLUME = 183'-10" x 150'-0" x 6.5' = 179,234 C.F.
 3.) DAYS STORAGE = 388 DAYS = 179,234 / 168,630 X 365

4144' TO NEAREST WATER SOURCE

3704' TO RESIDENCE

1624' TO SCHILLING RESIDENCE

3656' TO NEAREST RESIDENCE

PROPOSED HIGH POINT OF PERIMETER DRAIN TILE PLACED AROUND THE PIT FOOTING, SLOPE TILE @ 0.1% TO SW CORNER OF PIT.

PROPOSED 3300 HEAD SWINE CONFINEMENT BARN (185'-2" x 153'-4") WITH 8 CONCRETE PIT BELOW THE SLATTED-BARN FLOOR, BARN FLOOR ELEVATION 1084, BOTTOM OF PIT ELEVATION 1076

PROPOSED PERIMETER TILE TO CONNECT TO EXISTING FIELD TILE. LOCATE OUTLET PRIOR TO CONSTRUCTION

EXISTING TILE INTAKE (PRIVATE TILE TO BE REMOVED & REROUTED)

COUNTY TILE (75' SETBACK)

247' FROM CENTERLINE

LOADOUT

ASSUMED PROPERTY LINE

ASSUMED SOUTH LINE SECTION 32, T-110-N-R-36-W OF REDWOOD COUNTY, MINNESOTA

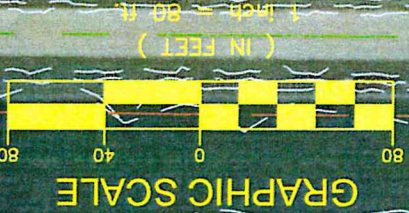

ProAs Engineering, Inc.
 77402 Highway 71, P.O. Box 181
 Jackson, MN 56143
 (507) 849-7200

TOM SCHILLING
 PROPOSED SWINE CONFINEMENT BARN
 SW 1/4, SECTION 32, T110N, R36W
 REDWOOD COUNTY, MINNESOTA

SHEET	Project No.	Checked By	Date	Drawn
2/8	18-012	N.J.R.	2/22/18	D.D.A.

PIT PLAN

153'-4" x 185'-2" x 8'-0"

*NOTE-PUMP/OUT LOCATIONS DETERMINED AT OWNERS DISCRETION

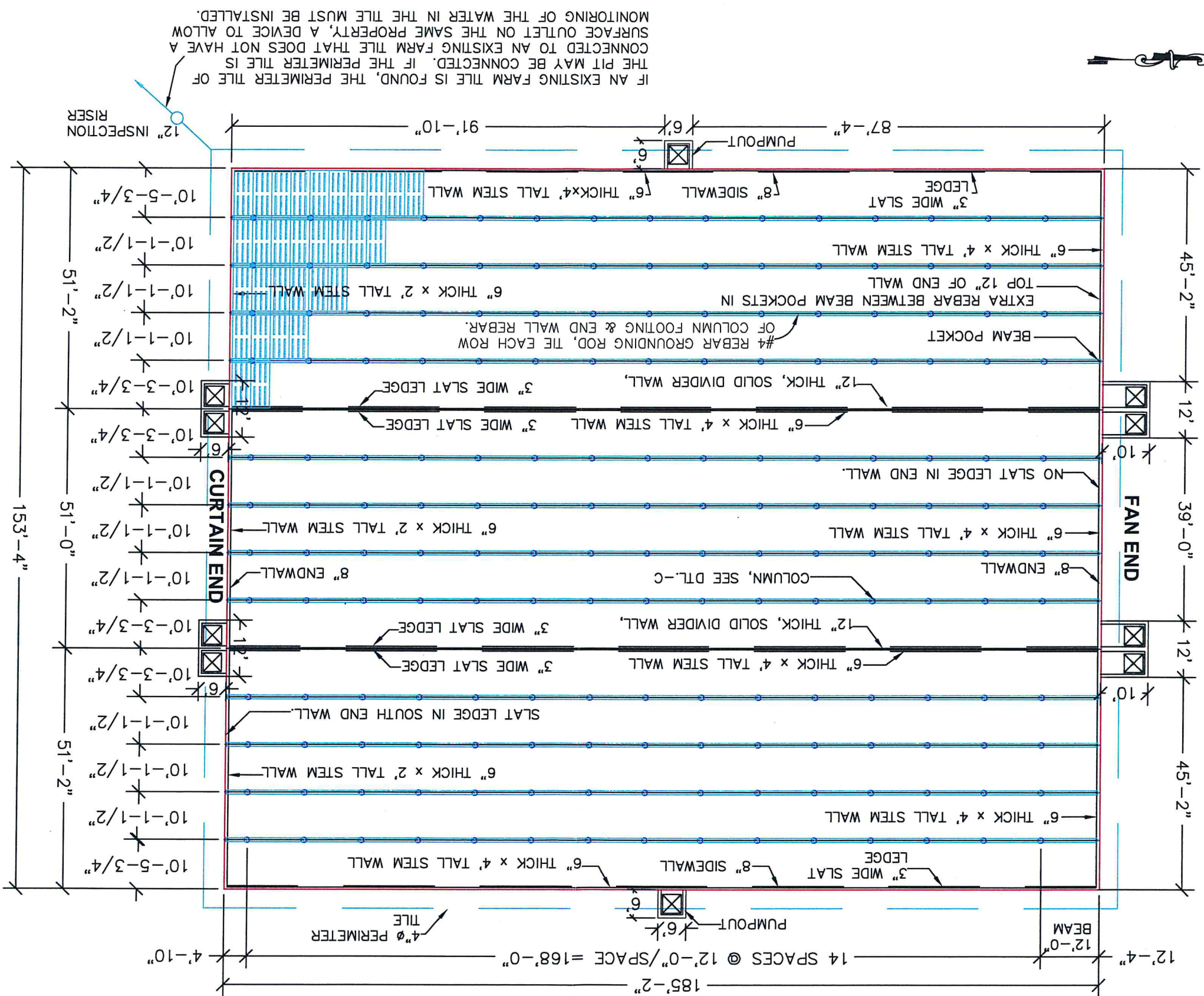

IF AN EXISTING FARM TILE IS FOUND, THE PERIMETER TILE OF THE PIT MAY BE CONNECTED. IF THE PERIMETER TILE IS CONNECTED TO AN EXISTING FARM TILE THAT DOES NOT HAVE A SURFACE OUTLET ON THE SAME PROPERTY, A DEVICE TO ALLOW MONITORING OF THE WATER IN THE TILE MUST BE INSTALLED.



ProAg Engineering, Inc.
 77402 Highway 71, P.O. Box 181
 Jackson, MN 56143
 (507) 849-7200

TOM SCHILLING
 PROPOSED SWINE CONFINEMENT BARN
 SW 1/4, SECTION 32, T110N, R36W
 REDWOOD COUNTY, MINNESOTA

SHEET	3/8	Project No.	18-012
	Drawn		D.D.A.
Date	2/22/18	Checked By	N.J.R.
	Drawn		D.D.A.

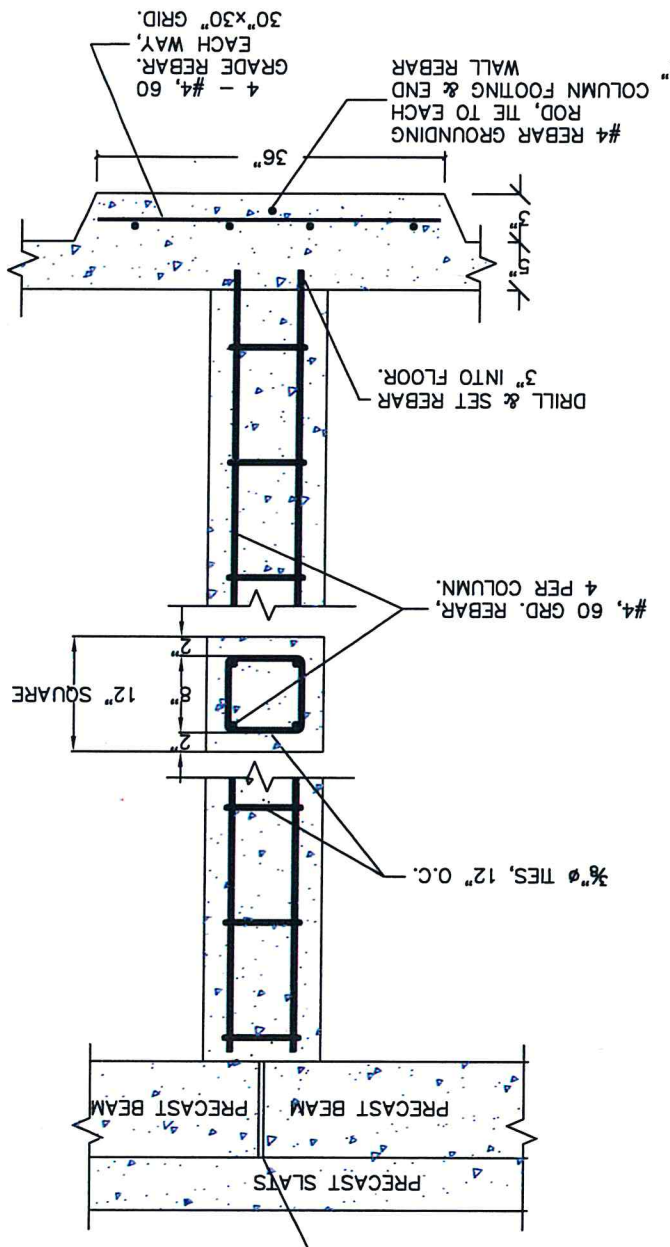
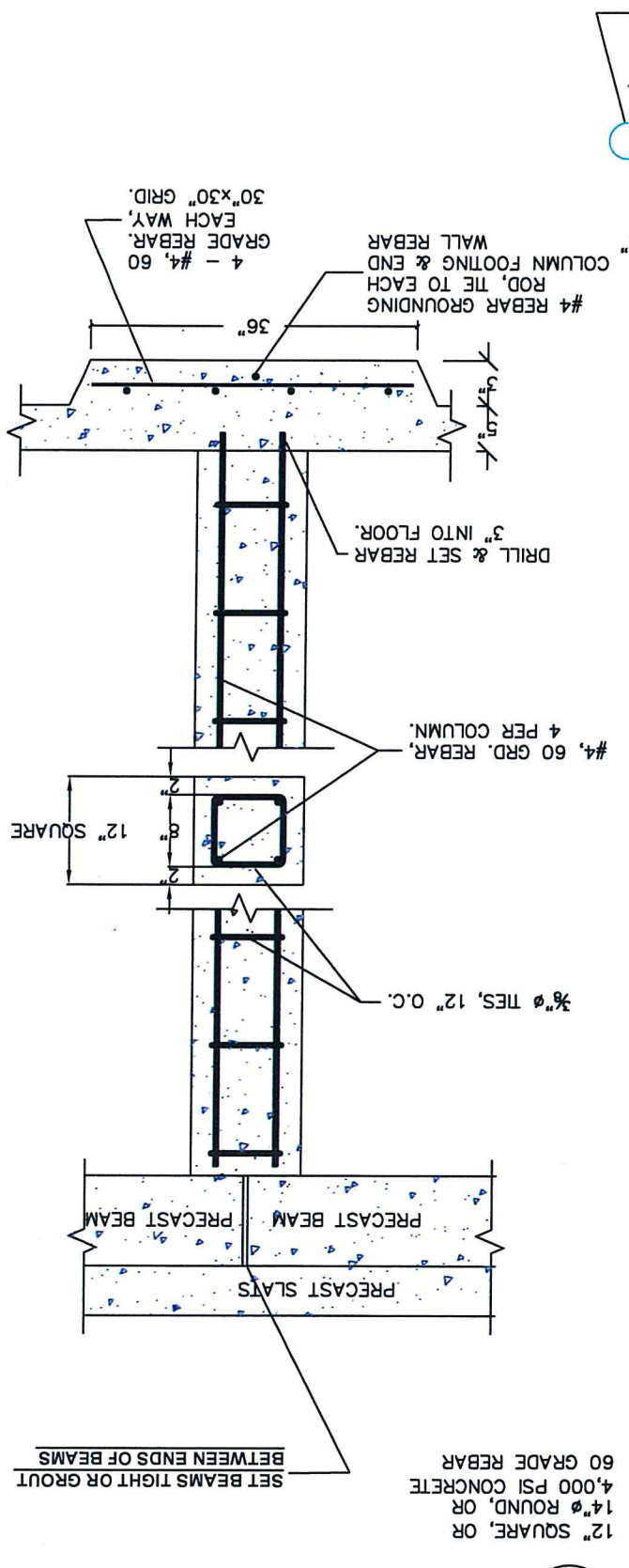
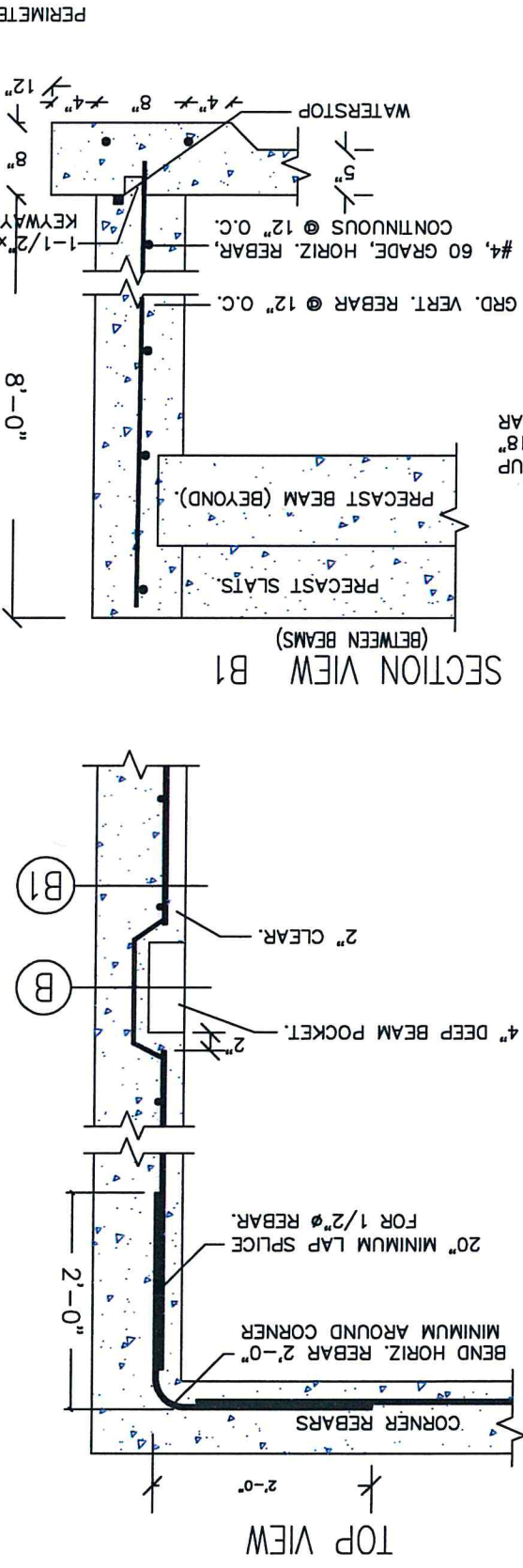
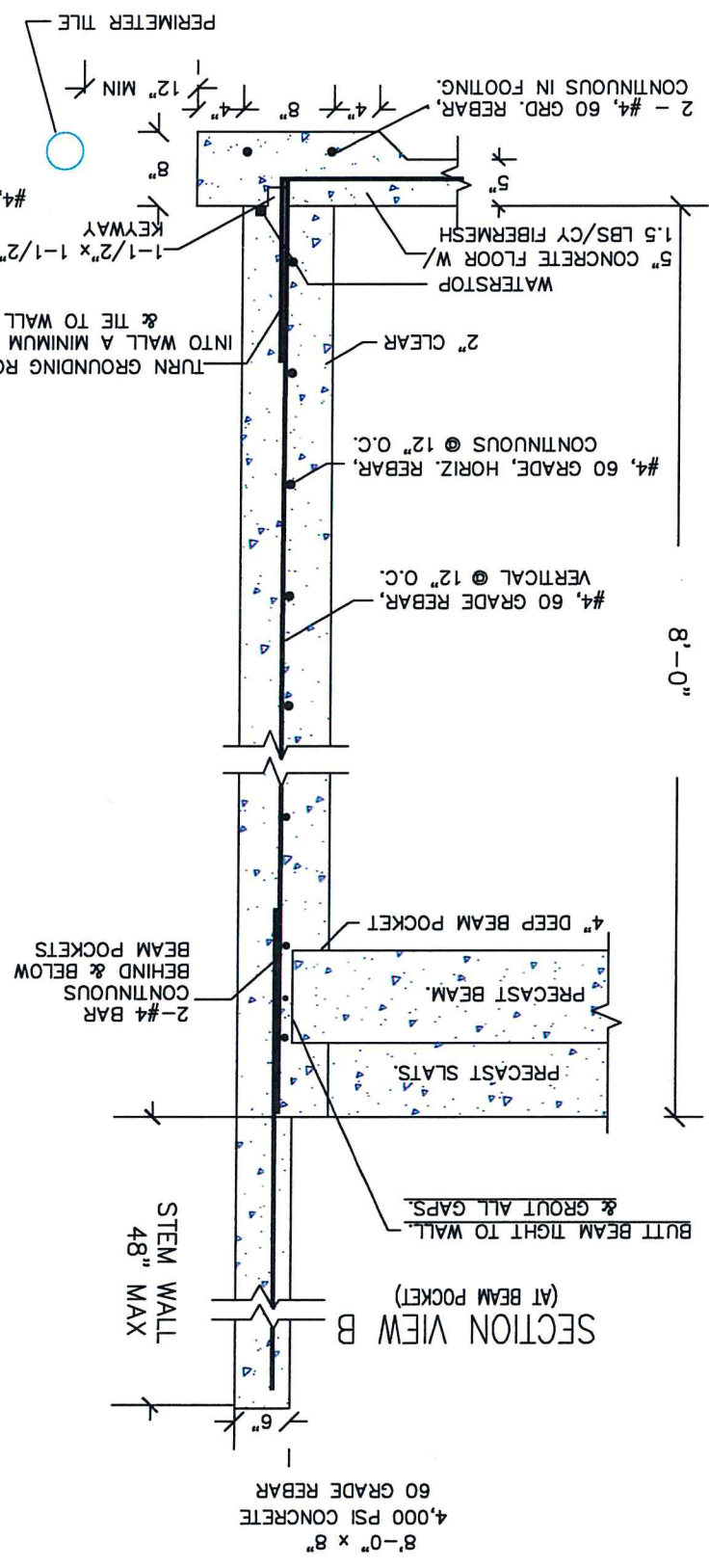
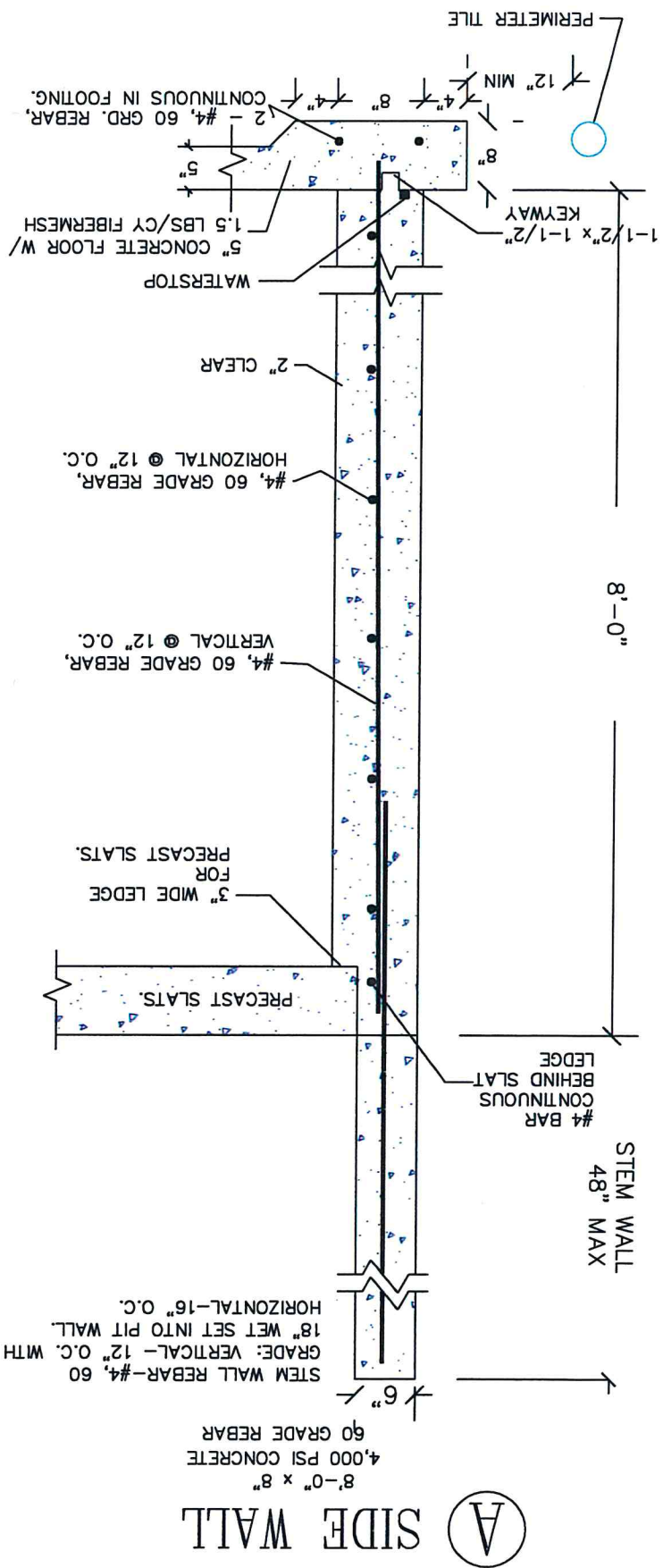

ProAg Engineering, Inc.
77402 Highway 71, P.O. Box 181
Jackson, MN 56143
(507) 849-7200

TOM SCHILLING
PROPOSED SWINE CONFINEMENT BARN
SW 1/4, SECTION 32, T110N, R36W
REDWOOD COUNTY, MINNESOTA

Date 2/22/18
Checked By N.J.R.
Project No. 18-012
SHEET 4/8

Drawn D.D.A.

PUMP OUT SECTION

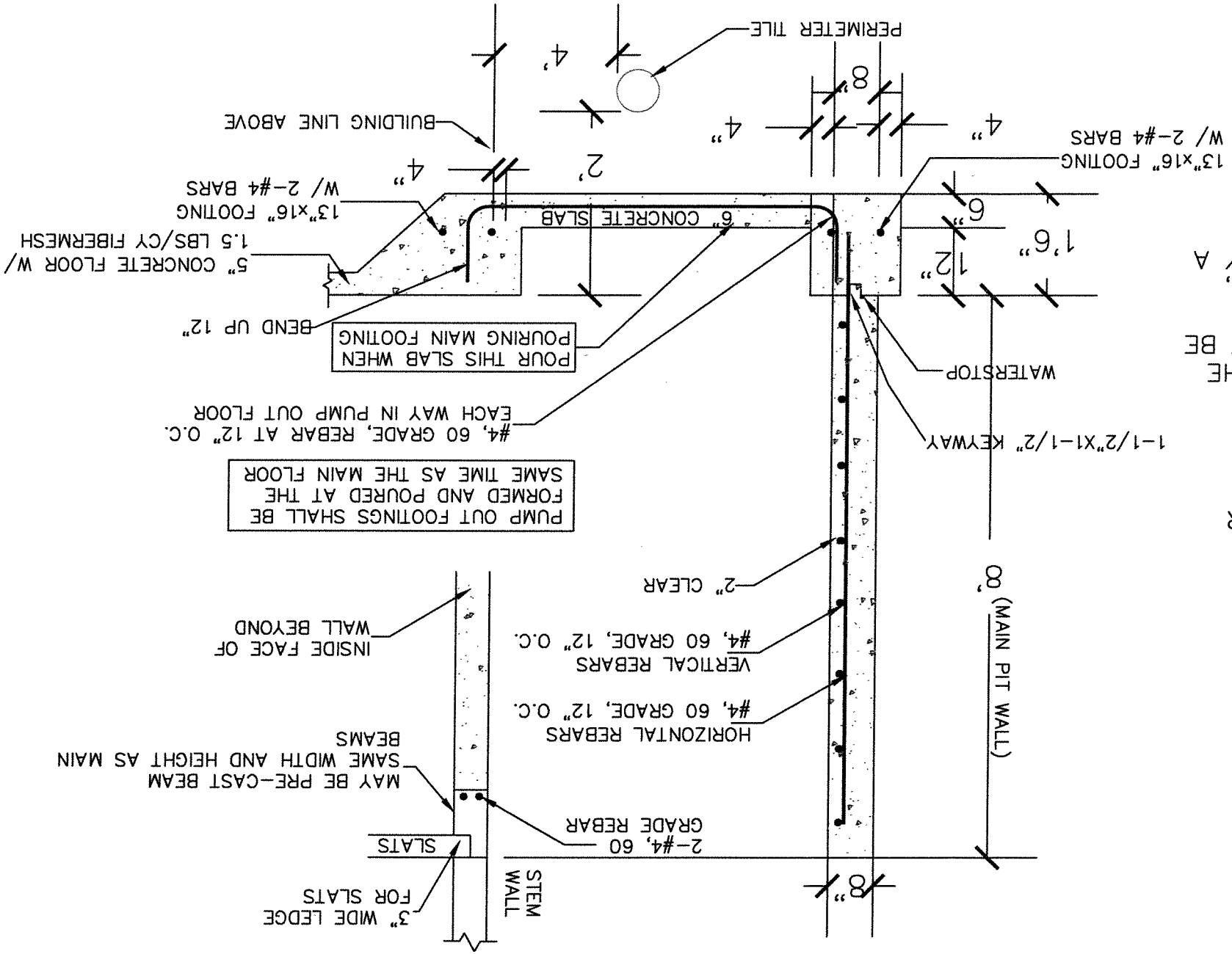

BEAM MAY BE CAST-IN-PLACE WITH STEM WALL. MINIMUM OF 2-#4, 60 GRADE REBARS IN BOTTOM OF BEAM.

PUMP OUT FOOTINGS AND FLOOR SHALL BE POURED WITHOUT CONSTRUCTION JOINTS—SEE DETAIL 1.

KEYWAY UNDER WALLS SHALL BE CONTINUOUS AROUND CORNERS AND PUMPOUTS.

CONSTRUCTION JOINTS ARE NOT TO BE WITHIN THREE (3) FEET OF A PUMPOUT.

CAUTION: DO NOT DRIVE STAKES THRU PERIMETER TILE.

8" THICK WALLS FOR 8'-0" DEEP PITS.

LOCATE PERIMETER TILE SO SIDE OF TRENCH BECOMES SIDE OF GENERAL EXCAVATION FOR PIT.

TO DEWATER THE SITE IN ADVANCE OF GENERAL EXCAVATION SHALL BE DECIDED BY THE OWNER, ENGINEER AND CONTRACTOR AT TIME OF THE PRECONSTRUCTION MEETING. IF THE TILE IS INSTALLED IN ADVANCE OF EXCAVATION, IT SHOULD BE INSTALLED 4 FT OUT FROM THE PIT WALL AND AT LEAST 2 FT BELOW THE TOP OF THE PIT FLOOR (IN ORDER TO GO UNDER PUMPOUT SUMP). SLOPE THE TILE AT 0.2 FT PER 100 FT TO THE SUMP OR DAYLIGHT OUTLET. FLOW TYPE MACHINES SHALL NOT BE USED WHEN INSTALLING PERIMETER TILE AROUND CONCRETE MANURE STORAGE STRUCTURES PRIOR TO GENERAL EXCAVATION, BECAUSE IT WILL LOOSEN SOIL UNDER WALL FOOTING. USE ONLY A BACKHOE OR TRENCHER.

****OWNER TO VERIFY PUMPOUT DIMENSIONS & LOCATIONS PRIOR TO CONSTRUCTION**

SHEET 6/8

Project No. 18-012

Checked By N.J.R.

Date 2/22/18
Drawn D.D.A.

TOM SCHELLING
PROPOSED SWINE CONFINEMENT BARN
SW 1/4, SECTION 32, T110N, R36W
REDWOOD COUNTY, MINNESOTA

ProAgg Engineering, Inc.
77402 Highway 71, P.O. Box 181
Jockson, MN 56143
(507) 849-7200

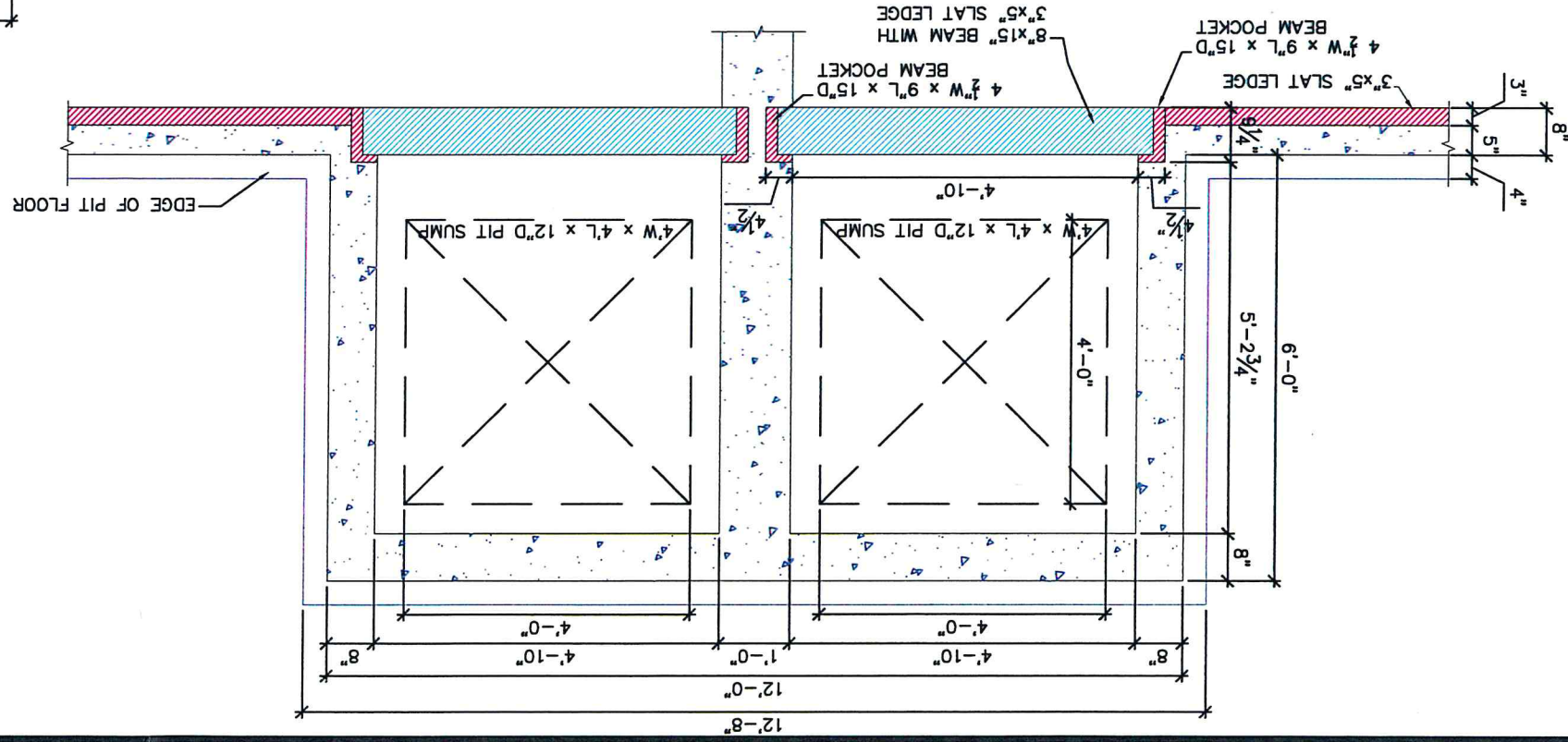

Curtain End Loud-Out

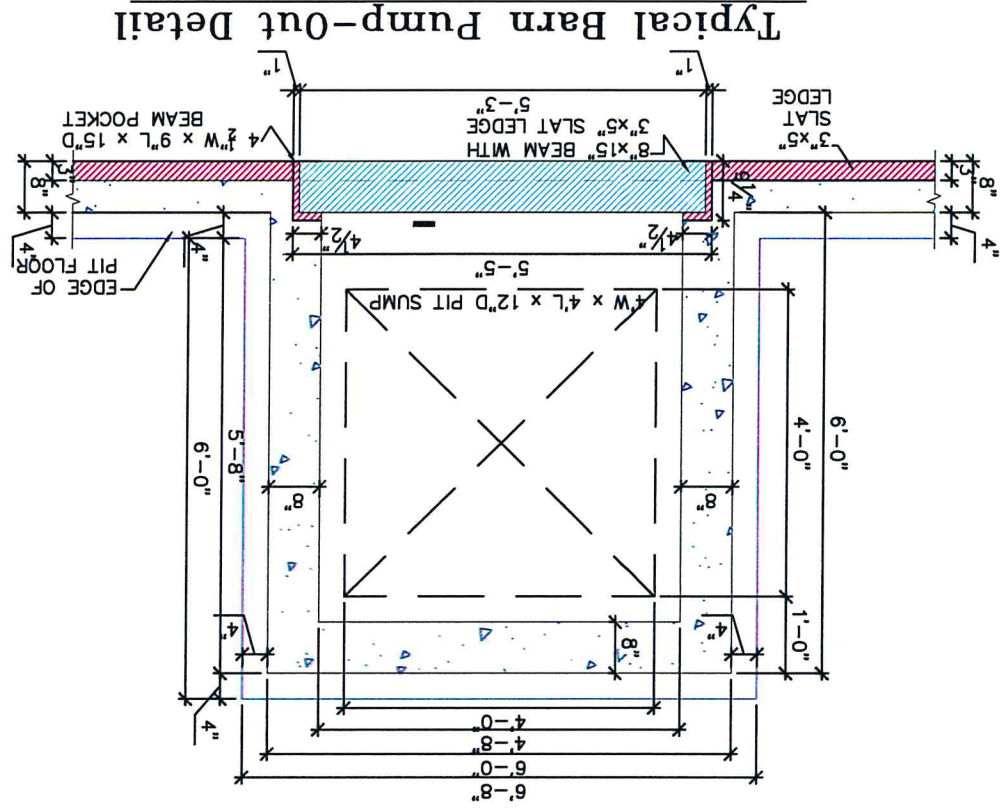

Typical Barn Pump-Out Detail

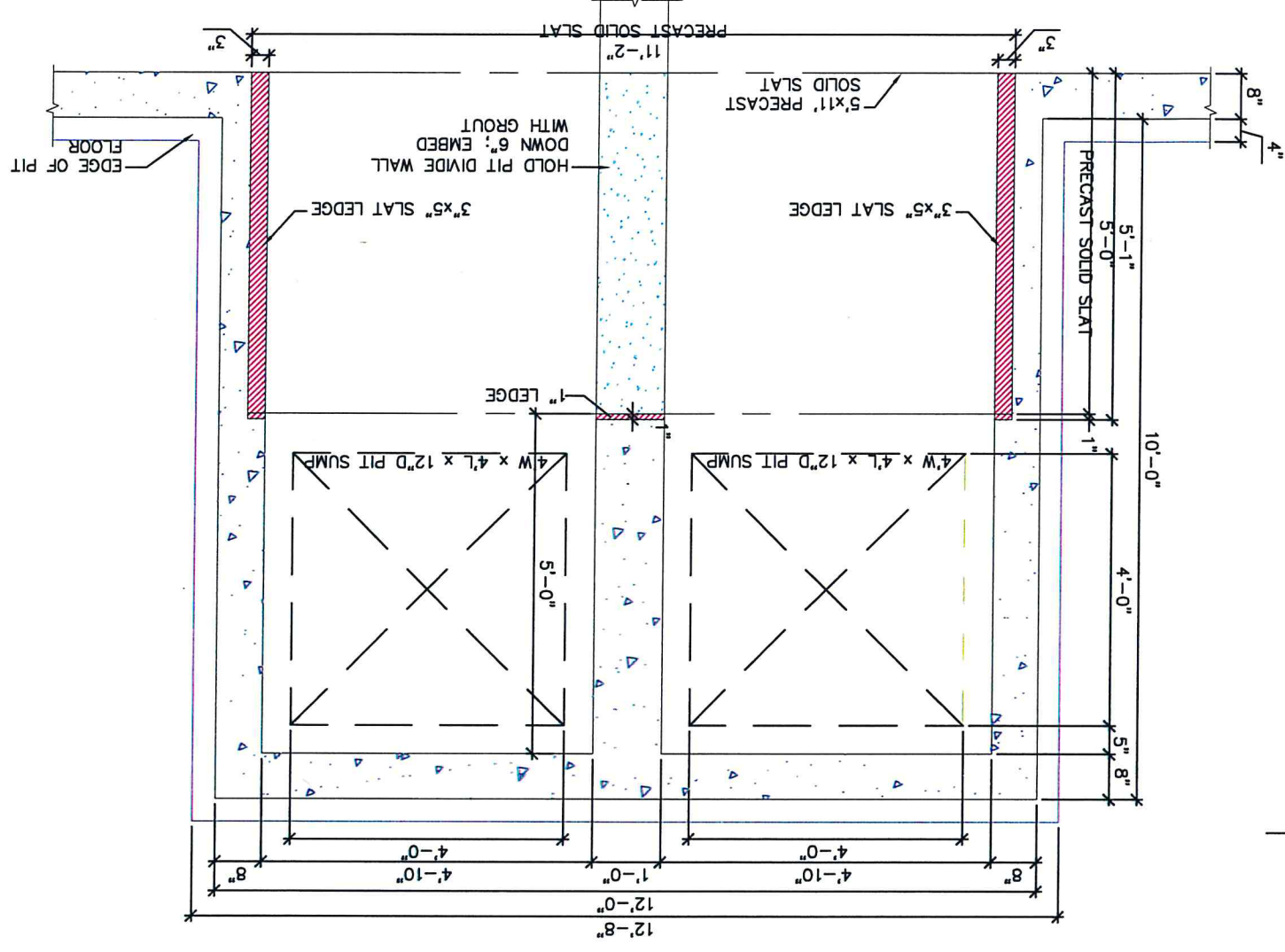

Fan End Loud-Out

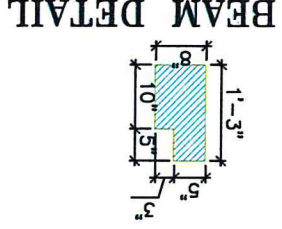
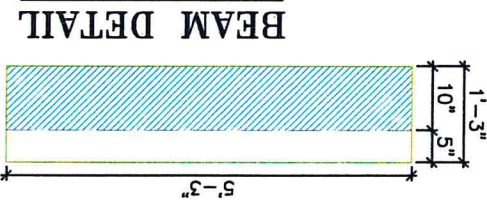

12" DIVIDER WALL

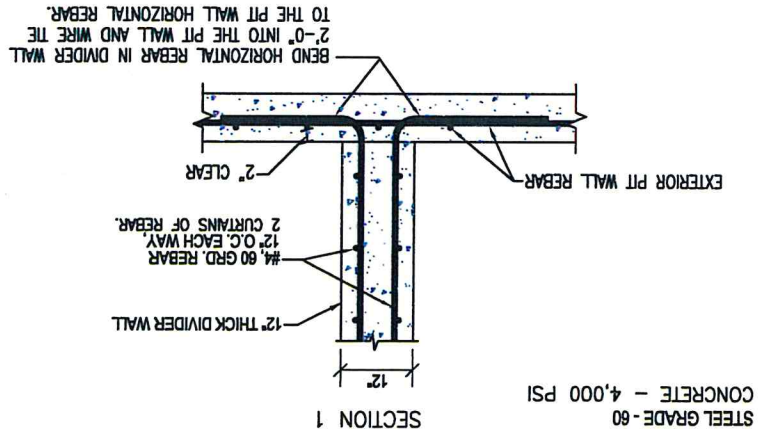

STEEL GRADE - 60
CONCRETE - 4,000 PSI

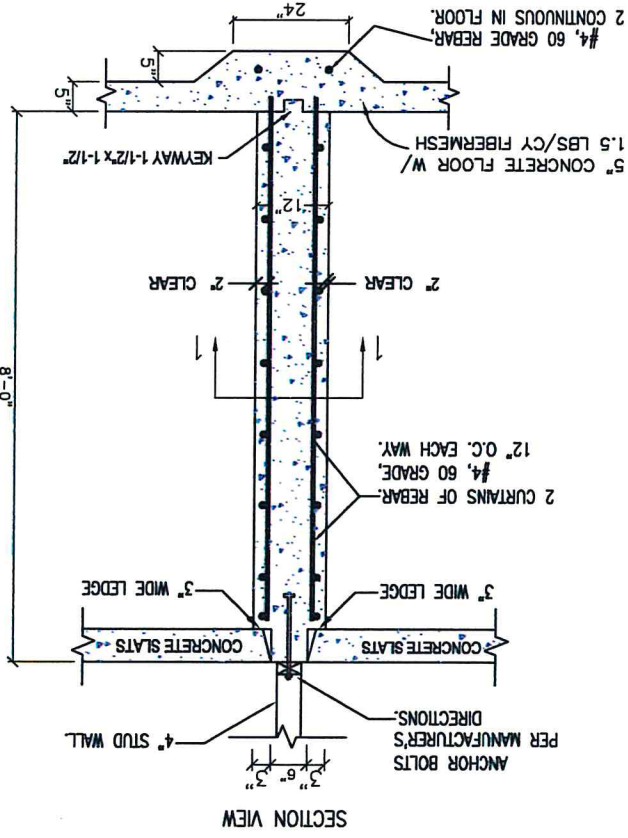

CONSTRUCTION JOINTS

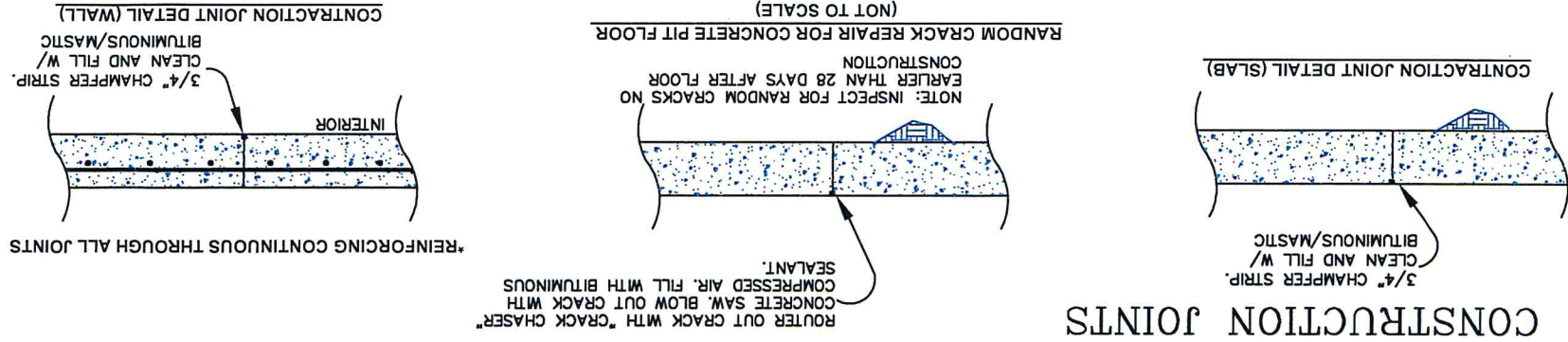

INSPECTION RISER DETAIL-SECTION VIEW

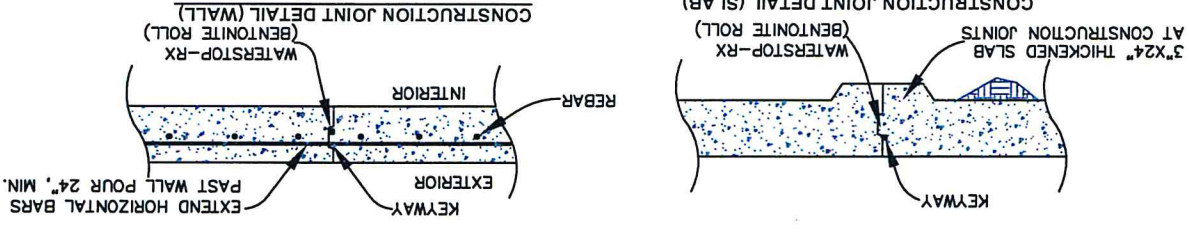
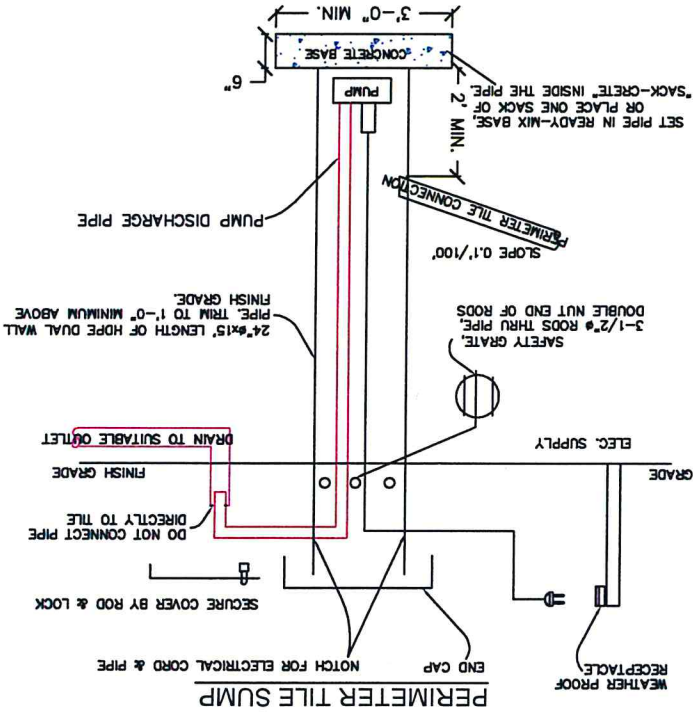
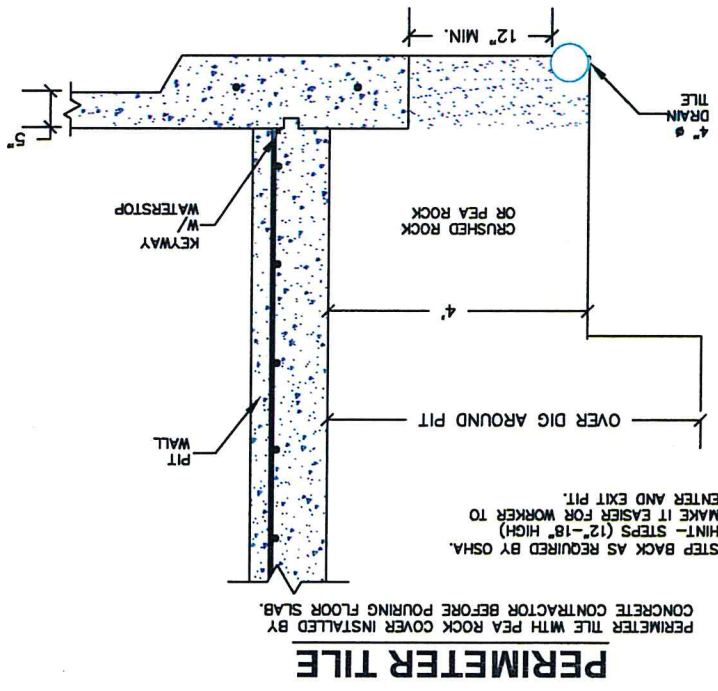
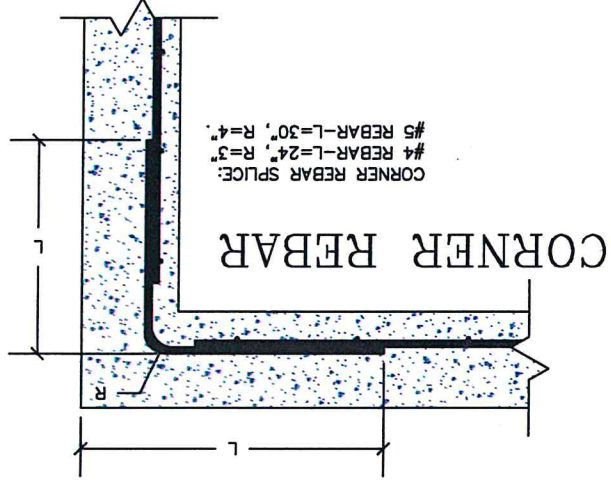
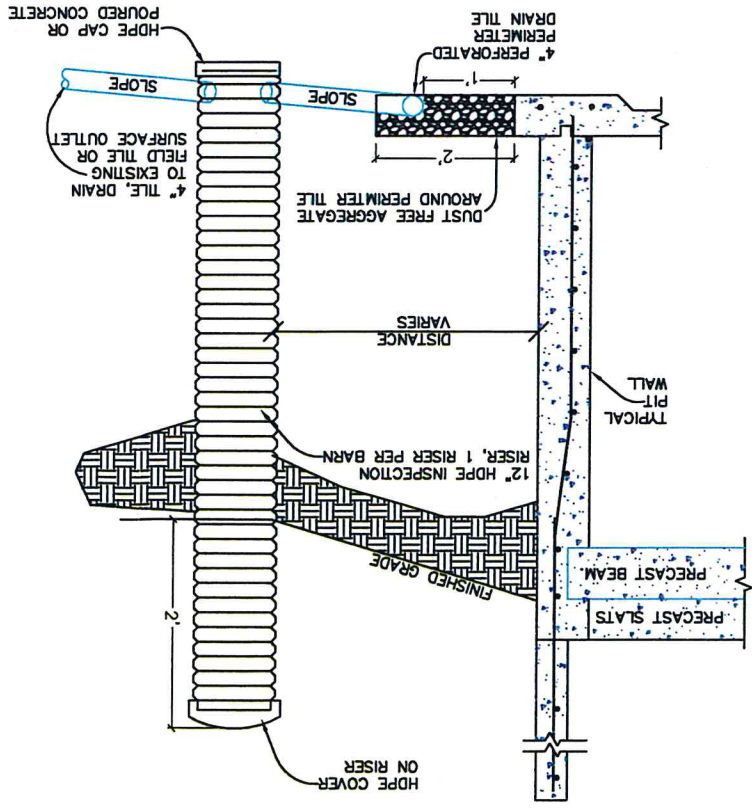

ProAg Engineering, Inc.
77402 Highway 71, P.O. Box 181
Jackson, MN 56143
(507) 849-7200

TOM SCHILLING
PROPOSED SWINE CONFINEMENT BARN
SW 1/4, SECTION 32, T110N, R36W
REDWOOD COUNTY, MINNESOTA

SHEET	7/8	Project No.	18-012
	Drawn		D.D.A.
Date	2/22/18	Checked By	N.J.R.

CONCRETE & STRUCTURAL NOTES:

- A. GENERAL**
- NOTES AND DETAILS ON THE STRUCTURAL DRAWINGS TAKE PRECEDENCE OVER THESE STRUCTURAL NOTES.
 - THE CONTRACTOR SHALL VERIFY ALL DIMENSIONS, ELEVATIONS, AND SITE CONDITIONS PRIOR TO STARTING WORK. THE ENGINEER SHALL BE NOTIFIED OF ANY DISCREPANCIES.
 - IN NO CASE SHALL DIMENSIONS BE SCALED FROM PLANS, SECTIONS, OR DETAILS ON THE STRUCTURAL DRAWINGS.
 - DESIGN CHANGES MUST BE APPROVED IN WRITING BY BOTH THE OWNER AND ENGINEER BEFORE PROCEEDING WITH THE WORK. SOME DESIGN CHANGES MAY ALSO REQUIRE MPCA, COUNTY FEEDLOT OFFICER AND/OR NRCS APPROVAL.
 - ANCHOR BOLTS SHALL BE SET AS SPECIFIED BY BUILDING CONTRACTOR.
 - ALL MATERIALS AND WORKMANSHIP SHALL CONFORM TO THE REQUIREMENTS OF THE FOLLOWING CODES:
 - UNIFORM BUILDING CODE (UBC)
 - MINNESOTA STATE BUILDING CODE
 - AMERICAN CONCRETE INSTITUTE (ACI)
 - CONCRETE REINFORCING STEEL INSTITUTE (CRSI) MANUAL OF STANDARD PRACTICE
 - B. DRAIN TILE**
 - BEFORE ANY PIT CONSTRUCTION, TRENCH AND INSTALL DRAIN AROUND THE PROPOSED PIT. THE DRAIN TILE FLOW LINE MUST BE A MINIMUM OF 12" BELOW THE TOP.
 - THE DRAIN TILE SHALL BE HEAVY DUTY PERFORATED POLYETHYLENE TUBING 4" Ø TILE WITH PEA ROCK COVER OR 4" Ø TILE W/ FABRIC SLEEVE AND SAND/GRAVEL COVER.
 - CONNECT THE DRAIN TILE TO AN EXISTING FARM TILE IF AVAILABLE; DISCHARGE TO SURFACE DRAINAGE; OR DRAIN TO A SUMP AND PUMP TO SURFACE.
 - C. TEMPORARY BRACING AND BACKFILL**
 - PROVIDE TEMPORARY LATERAL SUPPORT FOR ALL WALLS WHERE GRADE VARIES ON THE TWO SIDES UNTIL THE PERMANENT STRUCTURAL SUPPORT SYSTEM IS IN PLACE.
 - BACKFILL ONLY AFTER THE FLOOR SLATS OR SOLID FLOOR HAS BEEN INSTALLED.
 - DO NOT BACKFILL AGAINST WALL UNTIL SLATS ARE INSTALLED AND GROUTED.
 - CONCRETE IN ALL WALLS SHALL BE ALLOWED TO CURE FOR A MINIMUM OF 14 DAYS BEFORE BACKFILL IS PLACED AGAINST WALLS. EXERCISE CAUTION WHEN BACKFILLING TO BRING UP THE LEVEL UNIFORMLY ON ALL SIDES OF TANKS AND PITS.
 - D. FOOTINGS, FOUNDATIONS & SUBGRADE**
 - SOIL BEARING DESIGN VALUE: 3000 PSF (ASSUMED) ON VIRGIN SOIL OR COMPACTED FILL FOR FOOTINGS.
 - PROTECT FOUNDATION EXCAVATIONS FROM FROST. DO NOT PLACE CONCRETE ON FROZEN GROUND.
 - EXISTING DISTURBED SUBGRADE SHALL BE REGRADED TO 95% OF STANDARD PROCTOR DENSITY.
 - ALL FILL UNDER FOOTINGS AND SLAB SHALL BE COMPACTED TO A DRY DENSITY OF AT LEAST 95% OF MAXIMUM DRY DENSITY AS DETERMINED BY AASHTO T-180.
 - SAND FILL AS REQUIRED FOR LEVELING SUBGRADES SHALL BE PROVIDED AT ALL SLAB ON GRADE AREAS.
 - E. REINFORCED CONCRETE**
 - ALL CONCRETE AND REINFORCING WORK SHALL CONFORM TO AMERICAN CONCRETE INSTITUTE'S "STANDARD BUILDING CODE REQUIREMENTS FOR REINFORCED CONCRETE", (ACI 318-05)
 - CONCRETE SHALL HAVE A MINIMUM 28-DAY COMPRESSIVE STRENGTH OF $f'_c=3500$ PSI FLOOR, 4000 PSI WALLS.
 - WATER CEMENT RATIO SHALL BE 0.45 MAXIMUM
 - CEMENT SHALL CONFORM TO ASTM C150, TYPE 1.
 - COARSE AGGREGATE SHALL BE 1"
 - READY-MIX CONCRETE SHALL BE MIXED & DELIVERED IN ACCORDANCE WITH ASTM C94.
 - SLUMP SHALL BE MAXIMUM OF 5"
 - AIR CONTENT SHALL BE 5% TO 7%
 - CONCRETE TO BE CURED WITH SONOBORN CURE AND SEAL OR EQUAL.
 - AD MIXTURES MAY BE USED WITH PRIOR APPROVAL OF THE ENGINEER FOR THE PURPOSE OF INCREASING THE WORKABILITY BUT NOT TO REDUCE THE SPECIFIED MINIMUM CEMENT CONTENT. CALCIUM CHLORIDE SHALL NOT BE USED.
 - FLOORS SHALL BE 5" THK. WITH WITH 1-1/2#/CY OF 3/4" FIBRILLATED POLYPROPYLENE FIBERS.
 - REINFORCING STEEL SHALL BE PLACED IN THE CENTER OF CONCRETE PLACEMENT UNLESS NOTED OTHERWISE. STEEL MUST BE SUPPORTED WITH APPROPRIATE CHAIRS OR CONCRETE BLOCKS.
 - IF CONSTRUCTION JOINTS NECESSARY, COORDINATE LOCATION WITH ENGINEER.
 - CONSTRUCTION JOINTS ARE NOT PERMITTED IN THE END WALLS OR WITHIN 3 FT. OF A PUMP-OUT. THE PUMP-OUT FLOOR AND FOOTING MUST BE FORMED AND POURED WITH THE PIT FLOOR. THE PUMP-OUT WALLS MUST BE FORMED AND POURED WITH THE PIT WALLS.
 - F. STEEL**
 - F_y = GRADE 60 (60,000 PSI) DEFORMED STEEL.
 - REINFORCING SHALL BE CONTINUOUS AND LAP A MINIMUM OF 40 BAR DIAMETER UNLESS NOTED OTHERWISE. WELDED WIRE FABRIC SHALL BE LAPPED A MINIMUM OF EIGHT INCHES.
 - MINIMUM BENDING RADIUS SHALL BE 6 BAR DIAMETERS.
 - MINIMUM BEND AROUND CORNERS FOR #4 BARS - 24", FOR #5 BARS - 30".
 - ALL CONCRETE IS REINFORCED UNLESS SPECIFICALLY CALLED OUT AS "NOT REINFORCED". REINFORCE ALL CONCRETE NOT OTHERWISE SHOWN WITH THE SAME STEEL AS IN SIMILAR SECTIONS OR AREAS.
 - THE FOLLOWING MINIMUM CONCRETE COVER SHALL BE PROVIDED FOR REINFORCEMENT UNLESS OTHERWISE NOTED:

WHERE CAST AGAINST EARTH	3 INCHES
WALLS AND SLABS (EXPOSED TO EARTH OR WEATHER)	2 INCHES
OTHER	2 INCHES
 - G. TOLERANCES & QUALITY CONTROL**
 - COLUMN FINISH ELEVATIONS SHALL BE + OR - 1/4" FROM DESIGN ELEVATION.
 - WALL ALIGNMENT (HORIZONTAL) SHALL DEVIATE NO MORE THAN 1/4" IN 10 FT. NO MORE THAN 3/4" OVER THE FULL LENGTH OF WALL.
 - WALL BEARING LEDGE ELEVATIONS SHALL BE + OR - 1/4" FROM DESIGN ELEVATION IN 10 FT. AND NO MORE THAN 1/2" OVER THE FULL LENGTH OF WALL.
 - OVERALL FOUNDATION LENGTH & WIDTH DIMENSIONS AND DIAGONAL DIMENSIONS SHOULD BE WITHIN 1/2" OF PLAN DIMENSIONS.
 - HONEYCOMB AND SHRINKAGE CRACKS WIDER THAN THE THICKNESS OF A PLASTIC CREDIT CARD SHALL BE FILLED WITHIN 48 HOURS WITH CEMENT GROUT SLURRY MOPPED INTO THE CRACKS. DO THE GROUTING OF FLOOR CRACKS BEFORE DIRT AND EQUIPMENT ARE BROUGHT ON THE FLOOR.
 - H. ELECTRICAL GROUNDING**
 - INSTALL REINFORCING BARS AS PER ELECTRICAL CODE GROUND AT A MINIMUM LOCATIONS AS PER ELECTRICAL CODE NOTIFY THE LOCAL ELECTRICAL INSPECTOR FOR INSPECTION PRIOR TO PLACING CONCRETE.
 - I. COLD WEATHER CONCRETING**
 - WHEN, FOR MORE THAN 3 CONSECUTIVE DAYS, THE MEAN DAILY TEMPERATURE DROPS BELOW 40° F., THE CONTRACTOR SHALL PLACE AND PROTECT THE CONCRETE IN ACCORDANCE WITH ACI 306.
 - HOT WEATHER CONCRETING
 - WHEN IT IS LIKELY THAT TEMPERATURE BETWEEN 75° F AND 100° F WILL BE APPROACHED OR EXCEEDED; THAT LOW RELATIVE HUMIDITY IS PRESENT; OR WIND VELOCITY WILL EXCEED 10 MPH, THE CONTRACTOR SHALL PLACE & PROTECT THE CONCRETE IN ACCORDANCE WITH CHAPTERS 4 & 5 OF ACI 305.
 - K. WATERSTOPS & SEALANTS**
 - WATERSTOP TO BE RIBBED PVC, OR BENTONITE ROLL, AT CONTRACTORS OPTION.
 - 3/8"x3/4" BENTONITE/BUTYL RUBBER EQUAL TO WATERSTOP-RX BY AMERICAN COLLEID COMPANY WATERSTOPS SHALL BE PLACED IN ALL CONSTRUCTION JOINTS ON THE FLOOR AND IN THE WALLS. LOCATION AND NUMBER OF CONSTRUCTION JOINTS ARE TO BE DETERMINED BY THE CONTRACTOR. WATERSTOPS SHALL BE SUITABLE FOR USE WITH MANURE.
 - MAKE PVC WATERSTOP SPLICES WITH SPLICING IRON.
 - SEALANT TO BE ELASTOMETRIC POLYURETHANE OR BITUMINOUS ASPHALT BASED.

SLAT LEDGES & STEM WALL CONCRETE NOTES

- ANY SLAB ON GRADE WHICH WILL HAVE A VERTICAL WALL ON TOP SHALL HAVE A KEYWAY AND WATERSTOP AT SLAB/WALL INTERFACE.
- WATERSTOP TO BE BENTONITE ROLL OR RIBBED PVC @ CONTRACTORS OPTION.
- SLAT LEDGES MUST BE 3" WIDE x 5" HIGH.
- 12" CENTER DIVIDER WALLS: THE 3" WIDE x 5" LEDGE ON BOTH SIDES OF THE 12" WALL MUST BE FORMED AND POURED WITH THE WALL.
- 8" OUTSIDE WALLS: THE 3" WIDE x 5" LEDGE ON INSIDE SIDE OF 8" WALL MUST BE FORMED AND POURED WITH WALL.
- DO NOT POUR WALL AND SET SLATS ON TOP. DO NOT EVEN ASK, BECAUSE THE 5" HIGH STEM IS NEEDED FOR SLATS BRACING THE TOP OF WALL
- A CONSTRUCTION JOINT IS PERMITTED BETWEEN THE PIT WALL AND STEM WALL, BUT THE CONSTRUCTION JOINT MUST BE EQUAL OR HIGHER THAN THE TOP OF THE PRE-CAST SLATS.

<p>PROAG Engineering, Inc. 77402 Highway 71, P.O. Box 181 Jackson, MN 56143 (507) 849-7200</p>	<p>TOM SCHILLING PROPOSED SWINE CONFINEMENT BARN SW 1/4, SECTION 32, T110N, R36W REDWOOD COUNTY, MINNESOTA</p>	Date	2/22/18	Checked By	N.J.R.	Project No.	18-012
		Date	2/22/18	Drawn	D.D.A.	Project No.	18-012
SHEET 8/8							

PROJECT: Tom Schilling

PROJECT NO: 18-012

DRILLED BY: Contractor

CLASSIFIED BY: Travis Anderson

SOIL SAMPLE LOG

BORING NO: 1

DATE DRILLED: 2/6/2018

ProAg Engineering, Inc.
77402 Highway 71, P.O. Box 181

Jackson, MN 56143 (507)-849-7200

PROJECT: Tom Schilling

PROJECT NO: 18-012

DRILLED BY: Contractor

CLASSIFIED BY: Travis Anderson

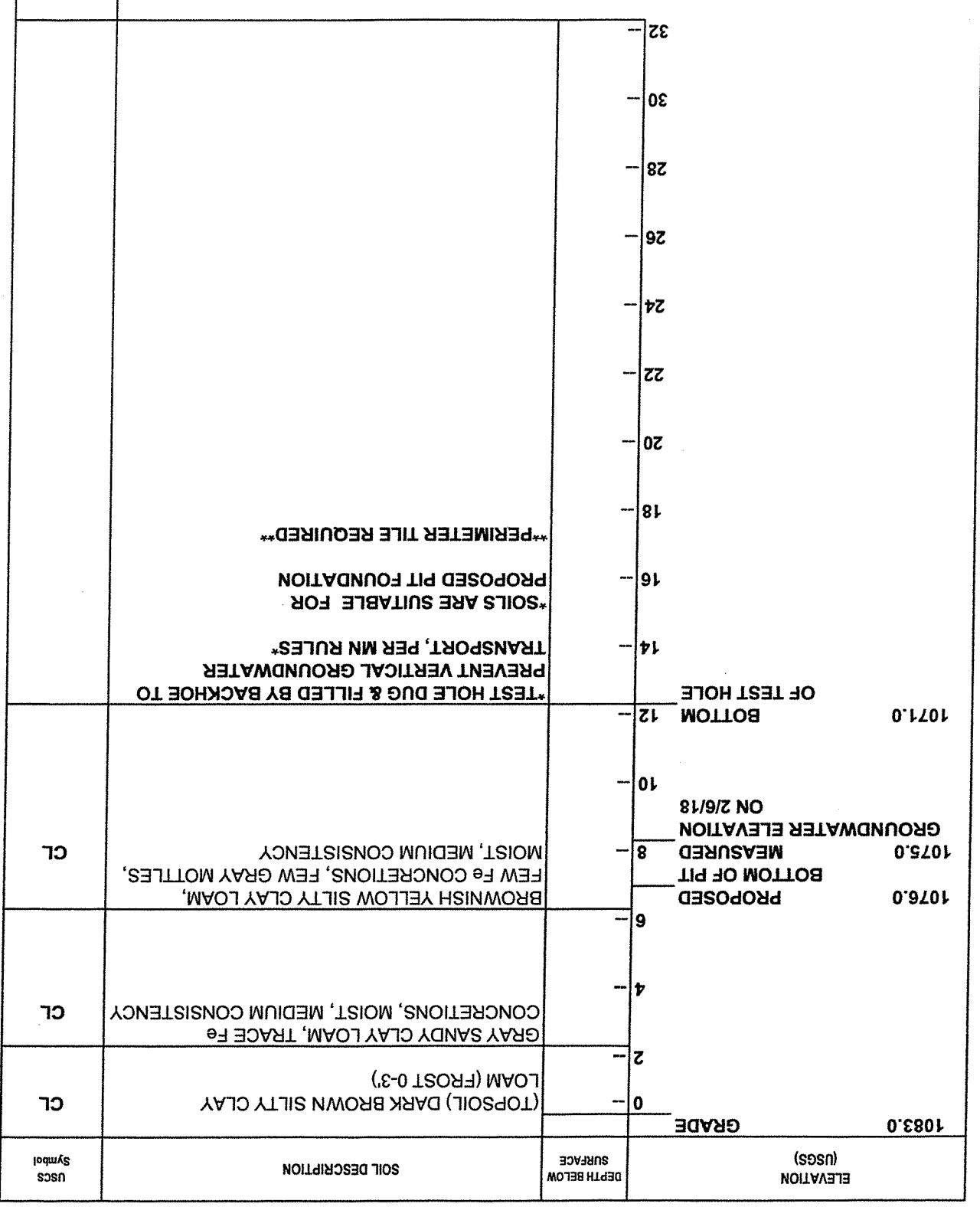
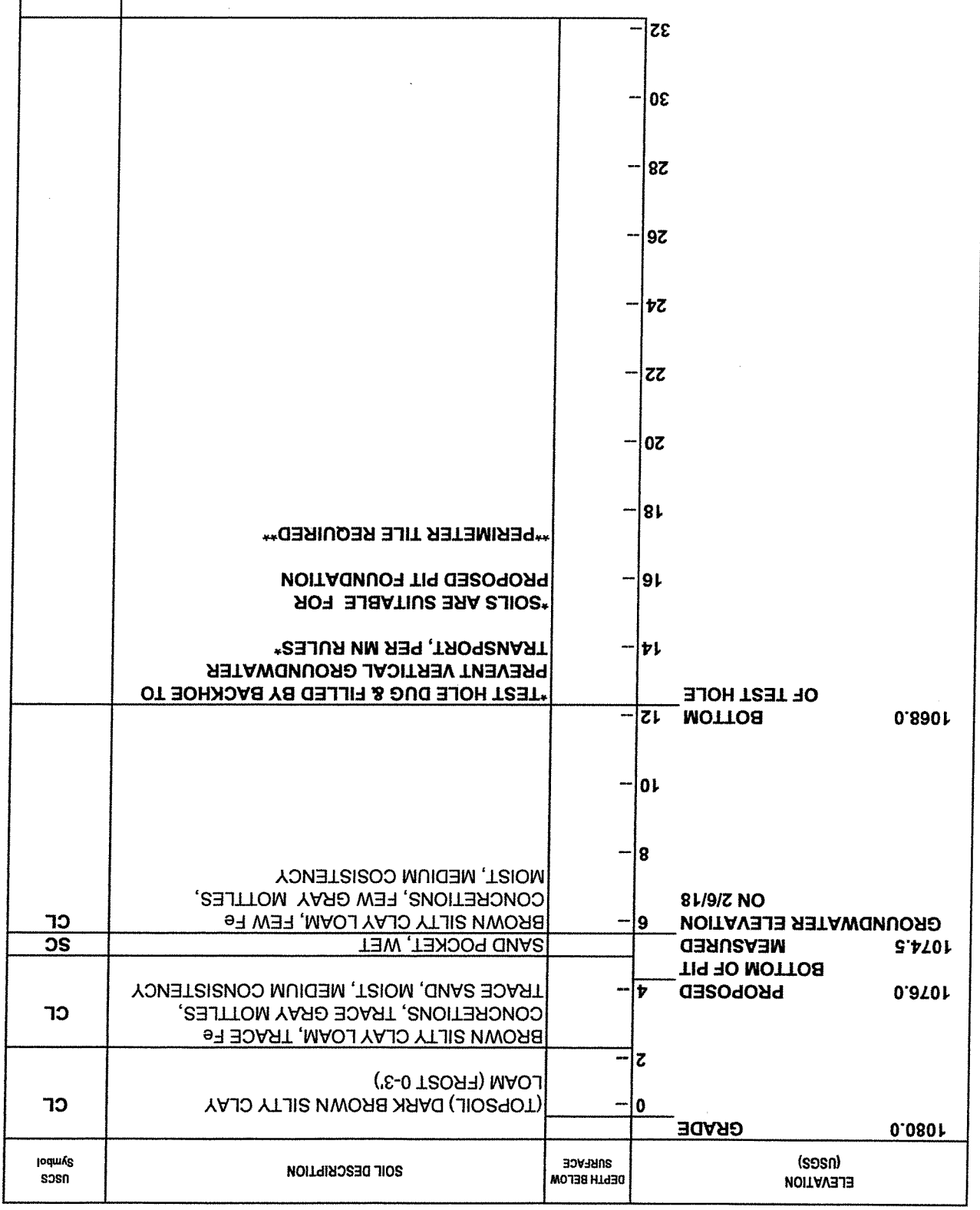

ProAg Engineering, Inc.
77402 Highway 71, P.O. Box 181
Jackson, MN 56143 (507)-849-7200

DATE DRILLED: 2/6/2018

BORING NO: 2

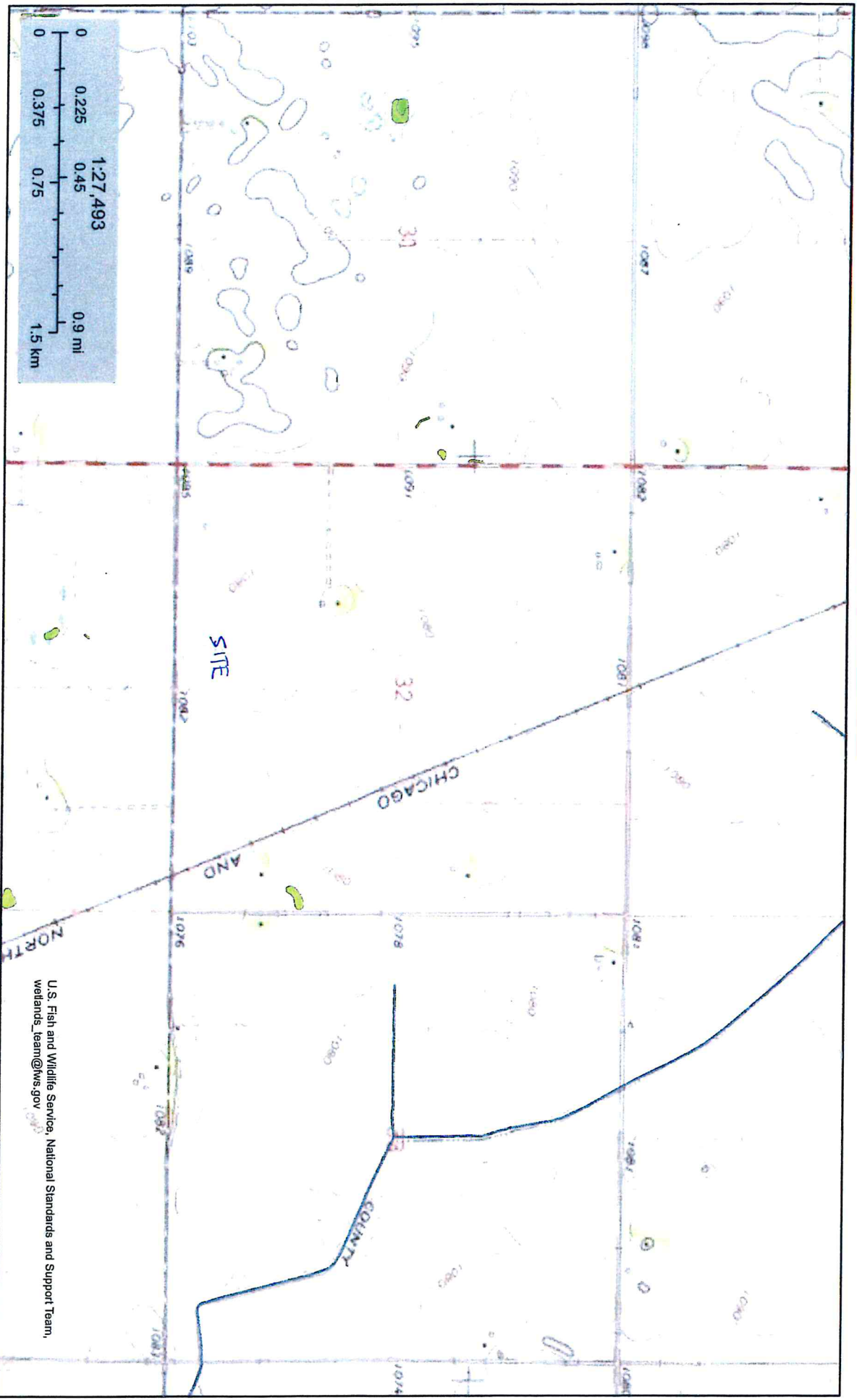

U.S. Fish and Wildlife Service, National Standards and Support Team,
 wetlands_team@fws.gov

This map is for general reference only. The US Fish and Wildlife Service is not responsible for the accuracy or currentness of the base data shown on this map. All wetlands related data should be used in accordance with the layer metadata found on the Wetlands Mapper web site.

National Wetlands Inventory (NWI)

- February 5, 2018
- Wetlands**
- Estuarine and Marine Deepwater
 - Estuarine and Marine Wetland
 - Freshwater Emergent Wetland
 - Freshwater Forested/Shrub Wetland
 - Freshwater Pond
 - Lake
 - Other
 - Riverine

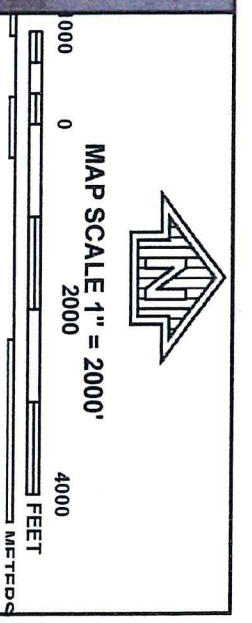

PANEL 0500C

FIRM
 FLOOD INSURANCE RATE MAP
 REDWOOD COUNTY,
 MINNESOTA
 AND INCORPORATED AREAS

PANEL 500 OF 700
 (SEE MAP INDEX FOR FIRM PANEL LAYOUT)

CONTAINS:

COMMUNITY	NUMBER	PANEL	SUFFIX
REDWOOD COUNTY	27084	0500	C
WANDA, CITY OF	27076	0500	C

Notice to User: The Map Number shown below should be used when placing map orders; the Community Number shown above should be used on insurance applications for the subject community.

MAP NUMBER
 27127C0500C
 EFFECTIVE DATE
 JULY 16, 2013

Federal Emergency Management Agency

This is an official copy of a portion of the above referenced flood map. It was extracted using F-MIT On-Line. This map does not reflect changes or amendments which may have been made subsequent to the date on the title block. For the latest product, please contact the National Flood Insurance Program flood maps check the FEMA Flood Map Store at www.msc.fema.gov



Soil Map—Redwood County, Minnesota

Map Unit Legend

Map Unit Symbol	Map Unit Name	Acres in AOI	Percent of AOI
86	Canisteo clay loam, 0 to 2 percent slopes	7.0	61.6%
423	Seaforth loam, 1 to 3 percent slopes	0.9	7.8%
999B2	Ves-Estherville-Storden complex, 3 to 6 percent slopes, eroded	0.3	2.2%
L163A	Okoboji silty clay loam, 0 to 1 percent slopes	3.2	28.3%
Totals for Area of Interest			100.0%
		11.3	

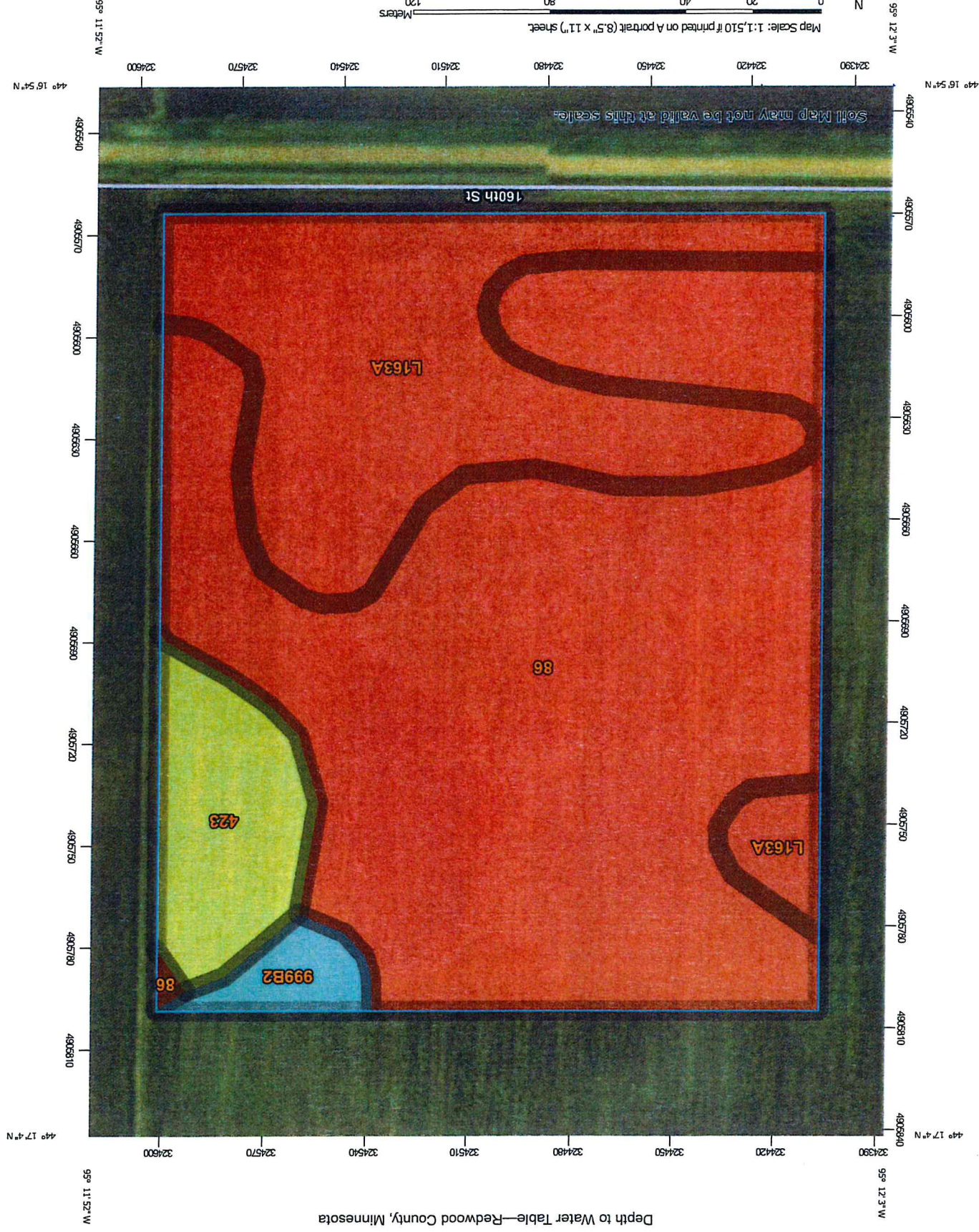

Depth to Water Table

Map unit symbol	Map unit name	Rating (centimeters)	Acres in AOI	Percent of AOI
86	Canisteo clay loam, 0 to 2 percent slopes	0	7.0	61.6%
423	Seaforth loam, 1 to 3 percent slopes	70	0.9	7.8%
999B2	Ves-Estherville-Storden complex, 3 to 6 percent slopes, eroded	110	0.3	2.2%
L163A	Okoboji silty clay loam, 0 to 1 percent slopes	0	3.2	28.3%
Totals for Area of Interest				100.0%
			11.3	

Description

"Water table" refers to a saturated zone in the soil. It occurs during specified months. Estimates of the upper limit are based mainly on observations of the water table at selected sites and on evidence of a saturated zone, namely grayish colors (redoximorphic features) in the soil. A saturated zone that lasts for less than a month is not considered a water table.

This attribute is actually recorded as three separate values in the database. A low value and a high value indicate the range of this attribute for the soil component. A "representative" value indicates the expected value of this attribute for the component. For this soil property, only the representative value is used.

Rating Options

Units of Measure: centimeters
 Aggregation Method: Dominant Component
 Component Percent Cutoff: None Specified
 Tie-break Rule: Lower
 Interpret Nulls as Zero: No
 Beginning Month: January
 Ending Month: December



U.S. Fish and Wildlife Service, National Standards and Support Team
wetlands_team@fws.gov

This map is for general reference only. The US Fish and Wildlife Service is not responsible for the accuracy or currentness of the base data shown on this map. All wetlands related data should be used in accordance with the layer metadata found on the Wetlands Mapper web site.

February 7, 2018

Wetlands

- Estuarine and Marine Deepwater
- Estuarine and Marine Wetland

- Freshwater Emergent Wetland
- Freshwater Forested/Shrub Wetland
- Freshwater Pond
- Lake
- Other
- Riverine

National Wetlands Inventory (NWI)

Date created: 2/7/2018
Last Data Updated: 2/6/2018 10:11:02 AM
Developed by
The Schneider Corporation
Schneider



- Minor Roads
- County
- State/Federal
- County/Twp/City
- Major Roads
- Parcels
- Address points
- Drain Tile
- Open Ditch
- Townships
- Counties
- Surrounding
- Sections
- Boundaries
- Municipal

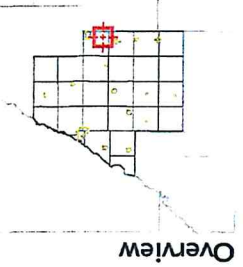

INSPECTIONS: *ProAg Engineering, Inc. must inspect before pouring concrete

Owner: _____

Location: _____

Barn or Tank Identification: _____

Date _____

Comment _____

Initials _____

Subgrade (No standing water or mud, forms set for proper floor thickness)

Floor Reinforcement (Grade, size, clean, location)

*Pouring Floor (Concrete, quality, take test cylinder

Floor (Cracks sealed)

Perimeter Tile, Monitoring Port or Sump & Pump, Tile Outlet (Functional before forming walls)

Wall Forms and Reinforcement (Grade of steel, spacing, vertical reinforcement secured)

*Pouring Walls (Concrete quality, take test cylinders)

Water Supply Lines (None permitted through pit floor or walls below the HW line)

Outside of Walls (Honeycomb patched prior to backfilling)

Inside of Walls (Honeycomb patched)

Walls (Do impact hammer test)

Columns (Honeycomb patched)

Beams Grouted (First 3 beams at end walls and each side of solid divider walls

Slats Grouted (Prior to backfilling)

Backfill (Height and slope to drain roof away from barns)

Finish Grading (Roads, drives, storm water catch basins & drainage)

TO: OWNER

INSTRUCTIONS FOR OWNER TO FOLLOW BEFORE—DURING—AFTER CONSTRUCTION OF MANURE STORAGE

ProAg
ENGINEERING, INC.
77402 U.S. Hwy 71
P.O. Box 181
Jackson, MN 56143
507-841-3269
nic@proageng.com

1. Distribute only complete sets of plans and specifications: Keep a record of who gets plans because you may need to retrieve them later. Please call if you need more copies.
2. Ask your feedlot officer to send a copy of your feedlot permit to ProAg Engineering, Inc.. We need this so we know who issued the permit and where reports should be sent.
3. Each Contract for construction of the liquid manure storage (Concrete, tilling earthen basins) should include the following statement:
- 10% of the contract amount will be held back until the MPCA Construction Inspection of Liquid Manure Area form has been signed by the Contractor and returned to the Engineer and Engineer certifies that the contract work is complete.
4. **A Pre-Construction Meeting shall be held before you start construction.** The pre-construction meeting must include the Owner, Engineer, Excavating Concrete Contractors, and County Feedlot Officer. If you start construction without a pre-construction meeting, we reserve the right to cancel our contract.
5. You must notify ProAg Engineering, Inc. and the Permitting Agency:
 1. Three days before you start construction.
 2. Three days before you backfill.
 3. Within three days of completion.
6. Pictures should be taken as the work progresses. This is good protection for you because if problems develop later, you will have a record of what was done. If the Engineer finds problems during inspection, he may request copies of the pictures. Close up pictures showing details are more important than panoramic views. Suggest using single use or digital cameras.
7. MPCA requires that the design engineer submit a written construction report. We cannot do our final inspection and impact hammer test until the concrete is at least 28 days old and all accessory details shown on plans and specs are completed. Then allow at least 2 weeks for us to inspect and write our report.
8. **DO NOT** make a final payment to contractor until the Engineer's certifies that work is complete.
9. **DO NOT put manure in the structure until you have received Engineer's Construction Report.**

PRE-CONSTRUCTION MEETING CHECK LIST
 OW-Owner, OR-Owner's Representative, CC-Concrete Contractor,
 EC-Electrical Contractor, EN-Engineer, EX-Excavator, PC-Precast Supplier
 ITEM RESPONSIBILITY

- 1) Telephone directory _____
- 2) Port-a-potty or Johnny-on-the-spot _____
- 3) Storm Water Pollution Prevention Plan, SWPPP, weekly inspections. _____
- 4) Stake out buildings and pits _____
- 5) Locate underground utilities _____
- 6) Call UTILITIES CALL CENTER _____
- 7) Notify Engineer three days before starting _____
- 8) Notify Engineer three days before backfilling _____
- 9) Notify Electrical Inspector for grounding inspections _____
- 10) Notify Engineer four hours before each concrete pour _____
- 11) Temporary electrical power _____
- 12) Temporary Water _____
- 13) Telephone service _____
- 14) Layout worksite, limits of worksite _____
- 15) Equipment and employee parking _____
- 16) Dirt stockpile area _____
- 17) Construction materials stockpile area(s) _____
- 18) Keep traffic off septic drainfield area(s) _____
- 19) Security (daytime, night time) _____
- 20) Bio-security _____
- 21) Refuse disposal dumpster/burn pit _____
- 22) Concrete truck wash-out area _____
- 23) Does everyone have correct plans? _____
- 24) At completion of construction, notify Engineer for final inspection _____
- 25) Contractor sign MPCA Construction Report _____

Nicholas J. Rowe, P.E.
 77402 U.S. Hwy 71
 P.O. Box 181
 Jackson, MN 56143
 507-841-3269
njc@proageng.com

ENGINEERING, INC.



PROJECT: _____ **DATE:** _____

LOCATION: _____ 1/4, SECTION _____, TWP. _____, CTY _____

OWNER: _____ **PHONE:** _____ (to)
 Owner's Representative _____ **PHONE:** _____
 conduct weekly inspections for SWPPP and notify Engineer and Feedlot Officer.)

GENERAL CONTRACTOR _____ **PHONE:** _____

EXCAVATION CONTRACTOR _____ **PHONE:** _____
 Date to start excavation work _____
 Contact _____

CONCRETE CONTRACTOR _____ **PHONE:** _____
 Date to start concrete work _____
 Contact _____

CONCRETE READY MIX _____ **PHONE:** _____
 Contact _____

PRE-CAST CONCRETE _____ **PHONE:** _____
 Contact _____

GROUPS, BEAMS AND SLATS _____ **PHONE:** _____
 Contact _____

FEEDLOT OFFICER _____ **PHONE:** _____

ELECTRICAL INSPECTOR _____ **PHONE:** _____

ENGINEER _____ **PHONE:** _____

01001 QUALITY ASSURANCE AND CONTROL PLAN

Work under these specifications is subject to County and MPCA inspection and review.

A. BEFORE STARTING CONSTRUCTION, Owner shall:

1. Consult the feedlot permit for required submittals, notifications and approvals.
2. Arrange for pre-construction meeting with engineer, owner and contractors.
3. Notify engineer, 3 days before starting construction.
4. Notify permitting agency (MPCA or County) 3 days before starting construction.

B. DURING CONSTRUCTION, Concrete Contractor shall:

1. Notify Engineer, minimum 4 hrs before each concrete pour.
2. Wait for Engineer's inspection before pouring concrete.
3. Concrete testing will occur at a minimum of one sample per 100 yards of placed concrete. Testing will include: Air/Slump/Strength per ASTM standards. Sampled concrete will be later tested at a certified testing facility to determine PSI strength requirements and quality assurance.
4. If concrete is provided by different supplier or with different mixes, additional testing will be done on the first truck according to ASTM standards. Engineer must be notified immediately if any change does occur.

C. BEFORE POURING CONCRETE PIT FLOORS, the following must be completed:

1. Contractor give Engineer & Electrical Inspector advance notice.
2. Engineer inspect subgrade and floor slab thickness (full 5" thick).
3. Engineer inspect grade and placement of reinforcing steel.
4. Perimeter tile shall be laid at least 12 inches from pit wall and covered with pea rock or 1/4" - 1/2" crushed rock.
5. Grounding inspection by Electrical Inspector.

Placement of the perimeter tile and rock cover shall be done by the Concrete Contractor. Tile and rock provided by Owner.

D. BEFORE POURING CONCRETE PIT WALLS, the following must be completed:

1. Contractor give Engineer & Electrical Inspector advance notice.
2. Engineer inspect forms, reinforcing steel, watershed and tile.
3. Tile system shall be working with (temporary or permanent) automatic sump pump or daylight outlet.
4. Grounding inspection by Electrical Inspector.

E. BEFORE BACKFILLING, Items 1 thru 4 must be complete, then Owner notify Engineer, and MPCA or CFO and allow 3 work days for inspection.

1. Concrete contractor shall have patched all cracks and honeycomb.
2. Pre-cast concrete beams, slats and slabs in place and grouted.
3. Permanent tile sump pump or inspection port set in-place, (braced if necessary) and ready for backfilling.
4. All organic debris shall be removed from the overdig area.
5. Engineer must inspect Items 1 thru 4 and approve before backfilling.

F. UPON COMPLETION, Owner shall notify Engineer when all of these items are done.

1. Backfilling and finish grading completed.
2. Pumpout covers and safety signs installed.
3. Concrete Contractor sign MPCA Construction Inspection Form.

G. ENGINEER shall conduct inspections as specified in Section 03001.B. and submit construction report to Owner and Permitting agency.

01301 DESIGN CHANGES

Design changes must be approved in writing by both the Owner and the Engineer before proceeding with the work. Some design changes may also require MPCA, COUNTY and/or NRCS approval.

01401 SITE SURVEY

The Contractor shall be responsible for layout of the work. Bidders must visit the site and acquaint themselves with existing conditions. Contractor shall CALL GOPHER-1 and be responsible for location of existing utilities in areas of work.

01501 SUBSURFACE INFORMATION

All available data relating to the subsurface material and conditions that are based upon test borings has been obtained by the Engineer for his/her own use in designing the project. Its accuracy or completeness is not guaranteed by the Owner or Engineer and in no event is it to be considered a part of the contact plans or specifications.

02101 EARTHWORK

A. This section applies to earthwork (excavation and backfill) for concrete lined manure storage pits and tanks.

B. Remove one foot (1') of topsoil under all concrete lined manure tanks. Save topsoil for finish grading.

C. Removal of water: All excavations, fill, grading and embankments shall be maintained in a well drained condition at all times. The Contractor shall have temporary pumping equipment on site to remove water from trenches and excavations until the perimeter tile system is working.

D. Any over-excavation for concrete footings and slabs on grade shall be backfilled with compacted sand/gravel.

E. WARNING Engineer must inspect outside of wall and tile and give approval before backfilling. See Section 01001.

F. CLEAN BACKFILL TRENCH. All organic material, cardboard, wood, paper, straw, etc. shall be removed from trench before backfilling. These materials will decay and contaminate the perimeter tile system.

02401 PERIMETER TILE SYSTEM

- G. Do not backfill against concrete walls until the concrete has cured at least 7 days and all slat and slab floors and beams are in place and grouted to properly brace the walls. Exercise caution when backfilling to bring up the level uniformly on all sides of tanks and pits. Keep all heavy equipment back from the pit and tank walls a distance equal to the depth of the fill. Top off backfill with one foot (1') of topsoil, disk and leave smooth for planting grass.

- A. PERIMETER TILE shall be 4 inch (unless otherwise shown on plans) heavy duty perforated corrugated polyethylene plastic agricultural drain pipe. Tile shall be bedded and covered with pea rock or 1/4" - 1/2" crushed rock.
- B. EXISTING TILE LINES intercepted during trenching for the perimeter tile system shall be removed back 10 feet from the tank wall. Existing tiles shall be connected to a suitable by-pass tile system. Do NOT connect existing area tile lines to the perimeter tile system, unless authorized by the Engineer.
- C. GRAVITY OUTLET FOR PERIMETER TILE shall not be used where flood water may backup into the tile and contaminate the dedicated sampling port. The tile outlet shall have a rodent guard. The tile outlet may serve as dedicated sampling port, when it is easily accessible and will never by inundated and contaminated by flood water.
- D. SUMP PUMPS shall be required whenever a gravity outlet is not available. On sites with more than one below ground manure storage structure, only one common sump pump system is required, but each structure must have an individual sampling port.
- E. PUMP shall be submersible type with 20 feet heavy duty electrical cord. Pump shall have an adjustable piggy back float switch. Pump shall be capable of 25 GPM at 15 feet head. Pump shall be fitted with a discharge hose or pipe equal or larger than the discharge of the pump. Furnish and install fused weatherproof disconnect switch, plug and receptacle for each pump. Plug type connections should be used for quick exchange of pumps by farm workers.
- F. ALTERNATE PLAN to dewater the site in advance of general excavation shall be decided by the owner, engineer and contractor at time of the pre-construction meeting. If the tile is installed in advance of excavation, it should be installed 4 feet out from the pit wall and at least 2 feet below the top of the pit floor. Slope the tile at 0.2 feet per 100 feet to the sump or daylight outlet. Plow type machines shall NOT be used when installing perimeter tile around concrete manure storage structures prior to general excavation, because it will loosen soil under wall footing. Use only a backhoe or trencher.
- G. CLEAN BACKFILL TRENCH. All organic material, cardboard, wood, paper, straw, etc. shall be removed from trench before backfilling. These materials will decay and contaminate the perimeter tile system.

02601 SEWER SYSTEM

- A. Sewer system consists of drains from the barns, cleanouts, sewer main, sewer outlet into concrete tanks and earthen basins, and level control between lagoon cells.
- B. Gravity sewer pipe (non-pressurized) shall be PVC SDR-35 with gasket or glued joints. Sewer cleanouts (CO) shall be located as shown on the plan.
- C. All holes for pipes passing through floors and walls shall be sealed water tight.

02701 FENCE AND GATES

All open top concrete tanks less than 4 feet of wall above ground and earthen manure storage basins shall be fenced. Fence and gates shall be child and livestock proof to prevent unsupervised access.

02801 SIGNS

The Owner shall post warning signs every 100-150 feet around open top tanks and earthen basins: "DANGER, DEEP WATER, KEEP OUT". Post warning sign at each manure pit, reception pit, pumping station and manhole where a 'confined space' may contain manure gases: "DANGER, POISONOUS GAS IN PIT, KEEP OUT".

02901 OTHER WORK

The Owner shall be responsible for putting child-proof fences around open top tanks and child-proof covers on all sumps, pump out ports and providing and utilizing safety guard fences around pump outs when open.

03000 PRECAST CONCRETE

- A. The Precast manufacturer shall submit design data for checking load capacity of the precast system or an Engineer's Certification that the pre-cast components meet the following design loads. For design of beams, slabs and slats refer to Concrete Manure Storages Handbook, MWPS-36, by Midwest Plan Service.

Type of barn	Solid slabs & beams	Slats
Hog nursery barns	35 psf	50 pft
Hog finishing barns	60 psf	125 pft
Sow & boar barns	65 psf	150 pft
Add an additional 160 pft on the edge(s) of slabs that support farrowing stalls.		
Dairy free-stall barns	100 psf	250 pft
Dairy holding & handling pens	125 psf	312 pft

- B. To properly brace pit or tank walls, space between ends of beams, slats and slabs shall be filled with grout and allowed to set 3 days before backfilling.

03001 CAST IN PLACE CONCRETE

- A. READY MIX CONCRETE shall meet requirements of ASTM C-94

CONTRACTOR shall give copy of this page to Ready Mix Plant prior to bidding.

Concrete 28 day compressive strength, f.c.psi	Aggregate, max.	Fibermesh
3,500	2"	1.5 lb/cuyd
4,000	1.5"	none
4,000	1.5"	none
Columns		
3" - 6"		
Slump		
Air entrained	5% - 7%	
Water:cement ratio	0.5	

Fly Ash, maximum 20% of cementitious material. Silica Fume, maximum 20% of cementitious material. The combination of fly ash and silica fume shall not exceed 35% of total cementitious materials. Fly ash and silica fume will increase resistance to sulfates and reduce permeability. CAUTION: fly ash slows curing, especially in cold weather.

To minimize shrinkage cracks in floors, minimize the amount of cement-water paste and maximize the amount of large aggregate. The use of water reducing plasticizers is encouraged. Contractor may order water reducing or other admixtures, except calcium chloride shall not be used.

B. INSPECTIONS AND TESTING.

1. Inspection before each concrete pour shall include evaluation of subgrade, forms, waterstop, placement and grade of reinforcing steel.
2. Concrete shall be sampled and tested for temperature, entrained air, slump and strength (test cylinders) as per ASTM C-94. Minimum of one sample per 100 yards placed.
3. The Inspector shall forward the inspection report including results of the ASTM tests to the Engineer.
4. The Engineer may request core samples be taken for any concrete of questionable strength or quality. All such concrete found to be defective shall be removed and replaced by the Contractor. If concrete is provided by different supplier or with different mixes, additional testing will be done on the first truck according to ASTM standards. Engineer must be notified immediately if any change does occur.

- C. WATERSTOP shall be 3/4" x 3/8" Waterstop RX; 3/4" x 1" Swellstop; Synko-Flex; Hydro-Flex waterstop; Green-streak, Con-Seal CS-231, 220 or 102, or approved equal. These materials come in paper-backed coil or strips and shall be applied as per manufacturer's instructions.
- D. All steel in the concrete floors and walls in livestock buildings must form an EQUIPOTENTIAL PLANE and be bonded to the electrical system. This must be coordinated with the Electrical Contractor and will require inspection by the Electrical Inspector prior to each pour of concrete.

- E. REINFORCING STEEL shall be deformed bars, fy = 60,000 psi (Grade 60)

Steel details for deformed rebar	#4 bars	#5 bars
Bar bending radius, minimum 6d3"	4"	
Lap splices, minimum 40d	20"	25"
Bend around corner, minimum	24"	30"
Rods through construction joints	30"	36"

- F. Steel reinforcement shall be tied and supported on chairs, bolsters, spacers and other devices. Dowels and rods extending through construction joints shall be secured in positions against displacement before concrete is placed and shall be cleaned before subsequent pouring.
- G. Preparation of Forms and Subgrade: Prior to placement of concrete, the forms and subgrade shall be free of wood chips, sawdust, debris, standing water, ice, snow, extraneous oil, mortar and other harmful substances or coatings. Placement of concrete on mud, dried earth, un-compacted fill or frozen subgrade will not be permitted.

EXPENSE.

- H. Excavations shall be made to the dimensions and elevations indicated on the drawings. Should excavation through error be carried to a greater depth or size than indicated or required, such additional depth or size shall be filled with concrete at the CONTRACTOR'S EXPENSE.
- I. Tolerances: Elevations of floor slabs, top of walls, slab ledges, beam pockets and top of columns ± 1/4". Horizontal length and width of top of wall, location of beam pockets and columns ± 1/2". Straightness of top of wall ± 1/4". Anchor bolt spacing ± 1", centered in stem wall ± 1/2". Thickness of floor slab shall not be less than 5 inches at any point.
- J. Shrinkage cracks and honeycomb areas shall be filled with a mixture of masonry cement and water of medium consistency and brushed into the cracks with a stiff brush. Honeycomb areas shall: 1) have loose stones hammered out, 2) be wetted by brushing in a watery paste of masonry cement, 3) and filled and sealed with mixture of masonry cement with sand.
- K. COLD WEATHER. When for more than 3 consecutive days the mean daily temperature drops below 40°F, the contractor shall place and protect the concrete in accordance with ACI 306.
- L. HOT WEATHER CONSTRUCTION. When it is likely that temperature between 80°F and 100°F will be approached or exceeded; that low relative humidity is present; or wind velocity will exceed 10 mph, the contractor shall place and protect the concrete in accordance with Chapters 4 & 5 of ACI 305.
- M. Freeze/Thaw & Non-Use Protection, Long & Short Term After Construction: After the concrete pit is constructed and prior to its use or during non-use, the concrete floor and subgrade must be protected from freezing. If the pit is empty when the ground surface around the pit begins to freeze, a minimum liquid depth of 2 feet must be added to the pit to prevent freezing the subgrade below the floor. If the barn and pit are not being used for any extended period of time throughout the year (minimum of 60 days), a minimum liquid depth of 2 feet must be maintained in the pit to prevent freezing, groundwater pressure heaving, etc. The barn can also be heated during non-use times during cold weather to prevent freezing in the bottom of the pit instead of placing or leaving additional liquid in the pit.

*These are recommendations and are not intended to meet the requirements of a site specific SWPPP for an NPDES Storm Water Discharge Permit.

Description of the site:

The site is currently cropland. The project consists of construction of a swine confinement operation with multiple deep pits. After construction, the area surrounding pit will be planted to grass.

Construction Sequence and Best Management Practices (BMP's)

1. The construction site shall be planted to grass (or cover crop) prior to commencement of construction. See Grass Seeding Guidelines.

2. Areas not to be disturbed during construction shall be staked and marked. Considerable rain water and sediment can be trapped on areas planted to grass and not compacted by construction traffic.

3. Install silt fence as shown on the site plan as needed to prevent erosion.

4. All drive entrances shall be protected with rock. Install road culvert(s) as per highway department specifications.

5. Build a berm to prevent field water from entering the construction site. Make berm 18-24" high with 3:1 side slopes. Use loose top soil from the barn area. A berm is an alternative to using silt fence. The loose soil will absorb a lot of water. Construct the berm on the contour with no channel on the up-hill side of the berm.

6. Temporary stockpiles shall have silt fence or other effective sediment controls and cannot be placed in stormwater conveyances, ditches or grass waterways.

7. Dewatering of pits and basins shall be done in a manner that does not cause nuisance conditions or discharge onto down-slope property. Rain and ground water in pit excavations shall not be allowed to flow direct into open tile, unless the tile inlet has silt fence or other protection or the perimeter tile is installed and covered with pea rock or crushed rock.

8. After backfilling and final grading is done, those areas shall be planted to grass. Slopes steeper than 5:1 shall be mulched. All seeding and mulching operations shall commence within 1 week after completion of each portion of the construction or as soon as soil conditions permit. See Grass Seeding Guidelines.

9. After berms are removed and backfill around barns is re-graded (the following spring) those areas shall be re-seeded to grass.
10. Final stabilization is achieved when soils have been stabilized by a uniform perennial vegetative cover over at least 70% of the previous area, and all drainage ditches and grass waterways have been stabilized, then the silt fence may be removed.

11. The Owner shall keep the plans and records on file for a minimum of six (6) years.

Maintenance of BMP's

1. Owner shall inspect all BMP's weekly and within 24 hours after each rain event of 1/2" or more in 24 hours.
2. Silt shall be removed from behind silt fences within 24 hours of when the depth reaches 1/3 the height of the fence.
3. Mud and crushed rock are tracked onto public roads, it shall be removed within 24 hours.
4. If sediment escapes the site, off-site accumulations must be removed in a manner and frequency sufficient to minimize off-site impacts.

Assignment of Responsibilities for Execution of the SWPPP

1. Owner shall be responsible for execution, inspection, record keeping and up-dating The SWPPP as required in Appendix C of the NPDES Feedlot Permit. See form for the Storm Water Pollution Prevention Plan Record.

2. Owner shall inspect all BMP's weekly and within 24 hours after each rain event of 1/2" or more in 24 hours and supervise proper maintenance of erosion and sediment control practices.

3. Earthwork Contractor shall be responsible for implement, manage and maintain both temporary and permanent erosion and sediment control BMP's (except seeding) until final grading has been completed on site.

4. Owner shall be responsible for seedbed preparation, planting and mulching operations prescribed by the SWPPP.

5. Changes to the SWPPP shall be approved and recorded by Owner prior to implementation.

Grass Seeding Guidelines

All in-place topsoil shall be salvaged to the maximum extent possible. It is ideal to place 6 inches of top soil in areas to be seeded. Harrowing before and packing with roller after planting will help germination, make the ground smoother and easier to mow. Seeding mixture and rates are recommendations based on DOT specs. Fertilizer is important for quick growth. Mixtures 250 and 280 can be mowed.

Temporary seeding: Fertilizer 10-10-20 at 200 lbs/acre.

- Cats at 100 lbs/ac for spring/summer seeding of areas that will be left undisturbed for 21 days or more.
- Winter wheat at 100 lbs/ac for fall seeding of areas that will be disturbed again in the spring, such as backfill around barns.

Turf and agricultural grasses: Fertilizer 20-10-20 at 350 lbs/acre.

General Roadside mix.		9.8 lbs/ac	
Brome grass, smooth	29.0	20.3	14.0%
Bluegrass, Kentucky "Certified Park"	9.8		
Bluegrass, Canada	14.0		
Switch grass	2.1		
Wheat-grass, slender	2.8		
Rye-grass, perennial	14.7		
Timothy	2.1		
Redtop	2.1		
Alfalfa, creeping	4.2		
White clover	2.1		
Total	3.0	70 lb/ac	
<hr/>			
Agricultural Roadside mix.		15 lb/ac	
Alfalfa, creeping	30.0%		
Brome grass, smooth	10		
Redtop	3		
Rye-grass, perennial	15		
Switch grass	2		
Timothy	2		
Wheat-grass, slender	3		
Total	6.0	50 lb/ac	

OPERATION, INSPECTION AND MAINTENANCE PLAN

NEED FOR OPERATION, INSPECTION AND MAINTENANCE PLAN

Although this Waste Storage Structure has been designed in accordance with MPCA recommendations and its based upon the best available technical knowledge, it must be recognized that any Waste Storage Structure needs to be properly maintained, including periodic inspection. You, the Owner, are responsible for this Waste Storage Structure. The following guidelines for safe operation and maintenance are recommended.

- (1) routine inspections, maintenance and record keeping to be completed to identify and document damage to the liner.
- (2) methods to be used to repair areas of damaged liner;
- (3) methods used to monitor the liquid level in the basin to evaluate proper operation and adequate available storage capacity; and
- (4) routine inspections of perimeter tile line outlets and inspection manholes to ensure proper operation of the system.

Annually, the liquid will be mixed and removed for land application. Liquid level in the pit(s) shall be monitored quarterly (4 times per year) and after any water line breaks or abnormal additions to the pit. The level shall be measured using a rod or wood stick and the depth recorded.

SEMI-ANNUAL INSPECTION OF LIQUID STORAGE AND HANDLING SYSTEMS

Establish a time each spring and fall for a thorough inspection of the liquid storage and handling systems. **DO NOT ENTER COVERED PITS & TANKS.**

All concrete storage tanks and reception pits shall be inspected to evaluate the outside of structures for cracks and deterioration of concrete. Any cracks showing discharge of liquid shall be inspected by an engineer and repairs done as prescribed by the engineer.

Maintain the following in proper working order:

- 1) Finish earthwork around the structure should be designed to carry runoff away from the foundation. Rainwater diversions to direct 'clean' water away and 'dirty' water into storage facilities. Grass should be established in those areas not covered by concrete and gravel.
- 2) Childproof covers must be placed upon the pumpouts. Open pumpouts should never be left unattended.
- 3) Warning signs shall be posted to prevent children and others from using the pit other than the intended use.
- 4) Animal wastes shall be handled and utilized as specified in the Manure Management Plan.
- 5) The Waste Storage Structure requires continuous ventilation to safely remove poisonous and noxious gases. Manure agitation will release large amounts of gas and may create a hazardous situation. Ensure that the ventilation fans are operating before agitation and, if possible, evacuate the building. Manure pits that contain bearing divider walls should be emptied using a modified pumping plan. All manure sections should be partially emptied to prevent possible divider wall failure. Removal of about 3/4 of manure is recommended from each section before complete emptying of any one section is undertaken.
- 7) No person should enter a Waste Storage Structure without proper training and without wearing a self-contained breathing device. A second person should remain outside of the structure and should have an immediate means of removing the person inside the structure in an emergency.
- 8) Regular quarterly inspections should be made of the structure and its surroundings for leaks, concrete deterioration and pumpout cover conditions. Inspection of the slats for signs of deterioration is advised.
- 9) Concrete should be inspected for large cracks and exposed reinforcing steel. Joints should be checked for unusual openings.
- 10) Concrete surfaces should be quarterly inspected for erosion, scaling and exposed reinforcing steel.

- 11) Perimeter tile, sump pumps, sampling ports and rodent guards at outlets.
- 12) The structure walls are designed to resist earth loads only. Do not operate any equipment on this surface.
- 13) The beam and flooring system is designed for animal loads only. Do not operate any equipment on this surface.
- 14) If, during the inspection, serious defects are discovered, remedial actions may be required. The County Feedlot Officer and Engineer should be contacted and possible the MPCA.

RECORDS

Record the inspections, evaluations and maintenance done in a spiral bound notebook. Also take and date pictures before and after any maintenance work is done on cover and liquid storage and handling facilities.

PERIMETER TILE MONITORING AND CONTINGENCY PLAN

INSPECT PERIMETER TILE AT LEAST ONE WEEK BEFORE EMPTYING STORAGE

All below ground waste storage structures require perimeter tile to relieve the hydrostatic pressures which would otherwise damage the sides of the concrete tanks and manure storage pits under barns. There is a serious problem if the water level in the sump or inspection port is above the pit floor.

It is very important that the ground water level be lowered prior to emptying the manure storage pit. It may take a week or more for the system to lower the ground water pressure once the problem has been corrected.

BASE LINE SAMPLING

It is recommended that base line sampling be done before manure is put in the storage facility to document any pre-existing contamination that may be in the soil. This is especially important if the site is in an old barn-yard area or has received heavy applications of manure for many years.

Base line samples should be collected at least two (2) times prior to the addition of manure into the waste storage structure. If there is no flow from the tile, sampling shall begin as soon as water is available for sampling. Each 'base line' sampling event shall be scheduled at least two (2) weeks apart.

- 1. The Owner shall contract with an independent laboratory to collect and analyze the samples. The laboratory must be certified. The laboratory report shall include: Chain of custody record, date, parameter, method used, results, units.
- 2. The water quality parameters to be monitored are:

Total Kjeldahl Nitrogen	Nitrate Nitrogen
Nitrite Nitrogen	Ammonium Nitrogen
Dissolved Oxygen	Chloride
Sulfate	Total Phosphorus
Fecal Coliform	pH
Temperature	Specific Conductivity
Flow (as determined by time to fill 5 gallon pail)	

CHANGE IN TILE WATER COLOR OR ODOR

If visual observation of the tile water indicates a change in color or odor, then a more urgent response is necessary. A change in color or odor may be caused by either soil and/or manure water. If this should occur, immediately stop all discharge to field tile. Notify the MPCA or Engineer immediately.

Install a sump pump and discharge the tile water onto a vegetated filter strip area. If necessary, plug the line going to field tile with bentonite chips. Bentonite chips may be obtained from your well driller.

Manure Storage, Handling, and Testing Information

Facility Name: Schilling Finisher Willow Lake 32 NPDES or SDS Permit? Yes Permit Number: _____
 Owner/Operator Name: Jon Schilling Date Last Revised: 4/1/2018 Registration Number: _____

Version 7.05 Last Updated: 10/12/16

	Manure Source #1	Manure Source #2	Manure Source #3	Manure Source #4
Manure Sources				
Description of Manure Source <small>Group sources with similar nutrient content if they have identical animal type, water usage, feed rations, and manure storage</small>	Finishing Pigs			
Livestock Information				
Predominate Animal Type <small>(Contributing to Manure Source)</small>	Swine- Wean/Finish (wet/dry feed)			
Average Animal Weight	140 lbs	lbs	lbs	lbs
Animal Number	3,300			
Length of Time Livestock Spend In Facility <small>Additional Animal Type (Contributing to Manure Source)</small>	355 days/yr	days/yr	days/yr	days/yr
Average Animal Weight	lbs	lbs	lbs	lbs
Animal Number	days/yr	days/yr	days/yr	days/yr
Length of Time Livestock Spend In Facility				
Storage Information				
Storage Type	Underfloor Concrete Pit			
Capacity	1,347,109 gals			
Storage Length	13 months			
Application Methods				
Commercial Applicator (Yes/No or Name)				
Spreader Type	Liquid Tanker			
How Volume/Tonnage Determined per Load	Spreader Volume			
How Application Rate is Calibrated	Acres Covered by One Load			
Manure Analysis - Existing facilities should use actual manure test results				
Sampling Frequency	Every Year			
Sampling Methods	Well Agitated Composite			
Date Last Analyzed				
Basis for N, P, & K Values Below	Average of Previous			
Total N - (do not enter lab estimated availability)	53 lbs/1000 gal			
Total P ₂ O ₅ - (do not enter lab estimated availability)	25 lbs/1000 gal			
Total K ₂ O - (do not enter lab estimated availability)	39 lbs/1000 gal			
Annual Generation - Existing facilities should use actual production values				
Total Manure Produced per Year (Estimated)	1,083,562 gals			
Total Manure Produced per Year (Actual)	750,000 gals	lbs	lbs	lbs
Annual N Produced	39,750 lbs	lbs	lbs	lbs
Annual P ₂ O ₅ Produced	18,750 lbs	lbs	lbs	lbs
Annual K ₂ O Produced	29,250 lbs	lbs	lbs	lbs

Average Book Values	
N	57
P ₂ O ₅	46
K ₂ O	34

Average Book Values	
N	
P ₂ O ₅	
K ₂ O	

Average Book Values	
N	
P ₂ O ₅	
K ₂ O	

Average Book Values	
N	
P ₂ O ₅	
K ₂ O	

Sensitive Features Management Worksheet

This worksheet identifies all allowable techniques that can be used to provide protection to sensitive features **as required** in Minnesota Rules and/or permit conditions. One of the following measures must be employed for the applicable sensitive feature. Any of the identified practices are acceptable.

Tile Intakes

- Option A - Inject or incorporate within 24 hours and prior to rainfall within 300 ft, observe a 25 ft non-manured setback, and avoid long term soil P build-up
- Option B - Inject or incorporate within 24 hours and prior to rainfall within 300 ft.
- Option C - 35 ft grassed buffer
- Option D - 100 ft setback with at least 16.5 ft as grassed buffer

Drainage Ditches

- Option A - Inject or incorporate within 24 hours and prior to rainfall within 300 ft, observe a 25 ft non-manured setback, and avoid long term soil P build-up
- Option B - 50 ft wide grassed buffer
- Option C - 100 ft setback with at least 16.5 ft as grassed buffer
- Option D - Protective Berm (prohibits runoff from entering the ditch)

Lakes, Rivers, and Streams

- Option A - Inject or incorporate within 24 hours and prior to rainfall within 300 ft, observe a 25 ft non-manured setback, and avoid long term soil P build-up
- Option B - 100 ft wide grassed buffer
- Option C - 100 ft setback with at least 16.5 ft as grassed buffer

Intermittent Streams and/or Public Waters Wetlands (over 10 acres)

- Option A - Inject or incorporate within 24 hours and prior to rainfall within 300 ft, observe a 25 ft non-manured setback, and avoid long term soil P build-up
- Option B - 50 ft wide grassed buffer
- Option C - 100 ft setback with at least 16.5 ft as grassed buffer

Wells, Mines, or Quarry

- Option A - 50 ft setback - minimum (100 ft if NPDES permitted)

Sinkholes

- Option A - Inject or incorporate within 24 hours and prior to rainfall upslope and within 300 ft and observe a 50 ft non-manured setback (100 ft non-manured setback for NPDES)
- Option B - Berm that prevents runoff from entering the sinkhole

Application of Manure During the Summer Months (June, July, and August)

- Option A - A cover crop will be planted on all fields that receive manure applications during June, July, and August

Other Conduits to Water

- Option A - Inject or incorporate within 24 hours and prior to rainfall within 300 ft, observe a 25 ft non-manured setback, and avoid long term soil P build-up
- Option B - 50 ft wide grassed buffer
- Option C - 100 ft setback with at least 16.5 ft as grassed buffer
- Option D - Protective Berm (prohibits runoff from entering the waters)

Early Fall Land Application - Unless otherwise required, this only applies to early fall manure application at NPDES or SDS permitted facilities

- Option A - Fall Application onto fields that are dominated by coarse-textured soils shall be delayed until soil temperatures in the upper six (6) inches, are less than 50 degrees Fahrenheit, unless otherwise first approved by the MPCA.

Soil Erosion Conservation Measures - Required for ANY field used for winter application and for ALL fields at NPDES permitted sites

- Option A - Establish grassed waterways
- Option B - Contour stripcropping
- Option C - No-Till cropping
- Option D - Terracing
- Option E - Meet tolerable soil erosion rates ("T") as defined by NRCS
- Option F - Use rotations that include other than row crops (alfalfa, grass, etc)
- Option G - Chisel or disk tillage with residue
- Option H - Field edge buffers
- Option I - Contour buffer strip
- Option J - Sediment control basin
- Option K - Plant a cover crop on bare ground

Nutrient Management Info for Methodology Portion of MMP

Nitrogen and Phosphorus Management

Even though no data entry or acknowledgement is required, this information is required as part of a complete MMP and must be followed.

Nitrogen Management - Nitrogen Management - Nitrogen Management

Based on the crop rotation, nutrient application rates will not exceed the nitrogen needs/removal of the crops as derived from the following MN Extension Service publications: "Manure Management in Minnesota" publication "WW-03553-C, Revised 2012", "Fertilizer Guidelines for Agronomic Crops in Minnesota" publication "BU-06240-S, Revised 2011", and "Nutrient Management for Commercial Fruit & Vegetable Crops in Minnesota" publication BU-05886, Revised 2005.
 Note: these publications have been incorporated into this planner.

Manure application rates will be calculated using the following factors:

- 1) Maximum Nitrogen needs for non-legumes and nitrogen removal for legumes will follow Tables A & C (included as part of planner)
- 2) Manure analysis test results (most recent or historical average)
- 3) Soil test results (where applicable)
- 4) First year nitrogen availability will be based on animal species and method of application as indicated in Table B (included as part of this planner)
- 5) If applicable, credits for previous crops and/or manure applications will be accounted for according to Tables A, B, & C (included as part of this planner)
- 6) If applicable, any fertilizer nitrogen applied will be accounted for in the calculations.

Any deviation from the maximum nitrogen applied will follow the standards allowed in Minn Rule 7020.2225, subp. 3 (A)(2) and the issued permit

Phosphorus Management - Phosphorus Management - Phosphorus Management

Phosphorus will be managed for all manure applications according to the following:

Manure application rates will be calculated using the following factors:

- 1) The calculations to determine crop P₂O₅ removal rate will be based on Table C (included as part of this planner)
- 2) For all animal species and all methods of application, the availability factor for phosphorus is 80 percent.
- 3) If applicable, any fertilizer P₂O₅ will be accounted for in the calculations.
- 4) When soil P test levels exceed 75 ppm Bray P1 (60 ppm Olsen) within 300 feet of an open tile intake, lake, stream, intermittent stream, drainage ditch without protective berms, or a public waters wetland, I will follow protocols listed in the issued permit.
- 5) When soil P test levels exceed 150 ppm Bray P1 (120 ppm Olsen) on any land, I will follow protocols listed in the issued permit.
- 6) Where winter-time manure application is approved, phosphorus management will follow rate restrictions listed in the issued permit.
- 7) In addition to items 1-6 I will manage Phosphorus according to one of the following options (either option is acceptable):

A) Minimum Phosphorus Management Based on Minnesota Rules

When the table below indicates soil test levels indicate phosphorus management is required, I will manage the rate and frequency of manure applications to not allow soil P build-up over any 6 year period, as required in the issued permit

B) Crop Phosphorus Removal Rates (over the rotation)

All manure will be applied according to phosphorus based rates, so that the rate and frequency of P₂O₅ applications will not exceed the expected crop P₂O₅ removal over the course of the crop rotation.

Minimum P₂O₅ Requirements

Bray P-1 (ppm)	Less than 22	22-75	76-150	Greater than 150
Olsen (ppm)	Less than 17	17-60	61-120	Greater than 120
More than 300 feet from waters*	No Phosphorus management requirements	No Phosphorus management requirements	No Phosphorus management requirements	Follow NPDES permit requirements
Less than 300 feet waters*	No Phosphorus management requirements	Prevent long-term build-up of soil P over a 6-year period (except open tile intakes)	Follow NPDES permit requirements	Follow NPDES permit requirements

* waters include: open tile lakes, streams, intermittent streams, protected wetlands, or unbermed drainage ditches

Sensitive Features Management Worksheet

Winter Application of Manure at NPDES & SDS Permitted Sites

Winter Application (frozen or snow-covered soils after November 30)



Solid Manure Applications - Solid Manure Applications - Solid Manure Applications

These practices are required for all fields that receive winter applications of solid manure:

- 1) No manure application within 300 feet of lakes, streams, intermittent streams, drainage ditches without berms, open tile intakes, wells, wetlands, and sinkholes
- 2) No manure application during snowmelt that creates runoff
- 3) No manure application when rainfall is likely within 24 hours
- 4) Only apply manure to areas of the field with slopes less than or equal to 6%
- 5) No manure application when ice/water completely fills furrows or depressional areas

Indicate why winter application of solid manure is necessary and why other alternatives are not feasible (stockpiling and/or applications during non-winter periods) **required**

- a) _____
- b) _____
- c) _____
- d) _____
- e) _____

NOT APPLICABLE TO THIS OPERATION

The Minnesota Phosphorus Index must be completed for all fields for winter application of solid manure.

All fields must meet a low to very low relative phosphorus loss risk index level (2 or less on average).

Include a copy of the P index input and outputs to verify the result

The Minnesota Phosphorus Index can be downloaded at the following link: <https://www.swac.umn.edu/extension-outreach/phosphorusloss>

Emergency Liquid Manure Applications - Emergency Liquid Manure Applications - Emergency Liquid Manure Applications

Winter application of liquid manure is prohibited by the NPDES & SDS permits except for emergency situations (as defined by the permit)

Emergencies include land application necessary to prevent Manure storage overflows at a site designed, constructed and managed to contain Manure during the winter, and where other options for additional temporary storage are not feasible. Emergencies are considered only those situations that are beyond the control of the permittee, such as unusual weather or unavoidable equipment failure.

Identify management alternatives that will be used to prevent and minimize needed emergency liquid applications during the winter (check all that apply)

- Transfer manure to other liquid manure storage at the facility.
- Transfer manure to other liquid manure storage not at the facility.
- Manure storage area will be pumped in fall to maximize capacity entering the winter season.
- Only the minimum amount of manure will be applied to alleviate the emergency situation; remaining manure will be applied after spring thaw.
- Other: _____

Requirements when emergency liquid applications are necessary (all management alternatives identified above have been exhausted)

- 1) Call both the **Minnesota Duty Officer** (800-422-0798) and the **MPCA** within 24 hours of an emergency application
- 2) No manure application within 300 feet of lakes, streams, intermittent streams, drainage ditches without berms, open tile intakes, wells, wetlands, and sinkholes
- 3) Only apply manure to areas of the field with slopes less than or equal to 4%
- 4) Maximum application rate of 3,500 gallons/acre/winter season not to exceed 60 pounds of P2O5/acre/winter season.
- 5) Utilize an application rate that prevents ponding or runoff during the application process.

Animal Mortality Management Worksheet

Indicate with a check mark the anticipated method(s) of dead animal disposal.

Rendering

Carcasses at the pick-up point will comply with the following:

Kept in an animal-proof, enclosed area.

At least 200 yards from a neighbor's buildings.

Picked up within 72 hours (7 days if refrigerated to less than 45 degrees).

Other: _____

Composting

The composting area will comply with the following:

Built on an impervious, weight-bearing pad that is large enough to allow equipment to maneuver.

Note: Class V gravel material is not considered to be impervious.

Covered with a roof to prevent excessive moisture on the composting material, but if sawdust or other water-repelling material is used as the bulking agent, a roof may not be necessary.

Built of rot-resistant material that is strong enough to withstand the force exerted by equipment.

Large enough to handle each day's normal mortality through the endpoint of the composting which consists of a minimum of two (2) heat cycles.

Other: _____

Burial

The following operational practices will be implemented

Stay 5 feet above seasonal high water table.

Stay 1000 feet away from lakes and 300 feet away from rivers, streams, ditches, etc.

Be covered immediately with enough soil to keep scavengers out (three feet is sufficient).

Not be placed in sandy or gravelly soil types.

Maintain at least 10 feet vertical separation between dead animals and bedrock.

Other: _____

Incineration

The incinerator will meet the following:

Capable of producing emissions not to exceed 20 percent opacity.

Fitted with an afterburner that maintains flue gases at 1,200 degrees Fahrenheit for at least 0.3 seconds.

Ash from the incinerator must be handled in such a manner as to prevent particulate matter from becoming airborne.

Other Method

The following operational practices will be implemented (describe the alternative method below)

MMP NOTES

This worksheet will allow entry of notes related to the MMP. This can be used to explain a part of the plan, notes regarding fertilizer/pesticide applications, or any other item that is applicable.

Simply start typing in any of the cells below, the cell will auto adjust to accommodate the length of the text entered.

Misc. Notes for all Fields <i>(Enter applicable notes for specific field ID's below)</i>	The barn will be built in 2018 so there will be no manure applied until 2019 at the earliest
Werner East	
Werner West	
Wanda/Schilling	
Home	

Land Application Agreement for Receiving Manure on Cropland

The undersigned landowner agrees to allow manure from _____'s livestock feedlot to be spread on 81.31 acres of his/her land. The land is located in the NW one-quarter of Section 19, in Willow Lake Township, of Redwood County.

The undersigned landowner is the holder of Permit Number NONE (if none is held, please indicate none).

If the land indicated above received manure from livestock in addition to that from the feedlot indicated above, please list the number and types of livestock below (if none, please indicate none):

NONE

Enclose a Farm Service Agency aerial photo of all areas on which manure will be spread. Outline the areas used.

Roger Werner
Signature of Landowner

This Agreement is Good Until 2033

ROGER WERNER
Name of Landowner

507 - 829 6237
Phone Number

1440 FRONT STREET
Address

WAB9550 MN 56293
City, State, Zip Code

FEB 15 2018
Date

Return Form To:

Land Application Agreement for Receiving Manure on Cropland

The undersigned landowner agrees to allow manure from _____'s livestock feedlot to be spread on 320 acres of his/her land. The land is located in the SW & NW one-quarter of Section 32030, in Willow Lake Township, of Redwood County.

The undersigned landowner is the holder of Permit Number NONE (if none is held, please indicate none).

If the land indicated above received manure from livestock in addition to that from the feedlot indicated above, please list the number and types of livestock below (if none, please indicate none):

NONE

Enclose a Farm Service Agency aerial photo of all areas on which manure will be spread. Outline the areas used.

Thomas J Schilling
Signature of Landowner

This Agreement is Good Until 2033

THOMAS J SCHILLING
Name of Landowner

507-327-8509
Phone Number

16327 Co Hwy 17
Address

LAMBERTON MN 56152
City, State, Zip Code

FEB 15 2018
Date

Return Form To:

Land Application Agreement for Receiving Manure on Cropland

The undersigned landowner agrees to allow manure from _____'s livestock feedlot to be spread on 20 acres of his land. The land is located in the NE one-quarter of Section 24, in WATERBURY Township, of Redwood County.

The undersigned landowner is the holder of Permit Number NONE (if none is held, please indicate none).

If the land indicated above received manure from livestock in addition to that from the feedlot indicated above, please list the number and types of livestock below (if none, please indicate none):

NONE

Enclose a Farm Service Agency aerial photo of all areas on which manure will be spread. Outline the areas used.

Roger Werner
Signature of Landowner

This Agreement is Good Until 2033

ROGER WERNER
Name of Landowner

507-829-6237
Phone Number

1440 FRONT STREET
Address

WABASSO MN 56293
City, State, Zip Code

Feb 15 2018
Date

Return Form To:

Werner East & West

W 1/2 NW 1/4 Section 19 Willow Lake

E 1/2 of NE 1/4 Section 24

Waterbury

● **TILE LOTAKES**

4

Jade Ave

Google Earth

© 2018 Google

1000 ft



Schilling/Wanda Farm

SW 1/4 Section 19 Willow Lake

180th St

Google Earth

© 2018 Google

Jade Ave

N Linn St

North St

N Cedar St S Cedar St

Wa

1000 ft



Schilling Home Farm

SW 1/4 Section 32 Willow Lake
• Fair Lakes



17

Justice Ave

160th St

1000 ft



Google Earth

© 2018 Google

**J & C Schilling
Farms, LLC**

153' X 185' X 8' 3300 head
SE 1/4 of SW 1/4 Section 32
Willow Lake, Redwood County



Justice Ave

7



* Well

Mortality Box

Google Earth

© 2018 Google

10000 ft



Odors From Feedlots Setback Estimation Tool

OFFSET Ver 2.0
University of Minnesota
12/10/17

Farm Name
 Address or County
 Evaluator
 Date

Clear All

OFFSET
Annoyance-free
98%

Source Edge to Nearest Neighbor (ft)
 Source Edge to Property Line (ft)

Building Sources

Building Type	Width (ft)	Length (ft)	# of Similar Sources	Total Area (sqft)	Control Technology	% air treated
Swine Finishing - deep pit ▼	185	153	1	28305	None ▼	
None ▼				0	None ▼	
None ▼				0	None ▼	
None ▼				0	None ▼	
None ▼				0	None ▼	
None ▼				0	None ▼	
None ▼				0	Biofilter ▼	

AREA SOURCES

Source Description	Shape	Width (ft) (or Dia)	Length (ft)	Area (sqft)	Control Technology
Earthen manure storage ▼	Rectangle ▼			0	None ▼
User added ▼	Rectangle ▼			0	None ▼
None ▼	Rectangle ▼			0	None ▼
None ▼	Rectangle ▼			0	None ▼
None ▼	Rectangle ▼			0	None ▼
None ▼	Rectangle ▼			0	None ▼
None ▼	Rectangle ▼			0	None ▼

Building Sources	
Add Source Type	
Name of Source	<input type="text"/>
Odor Flux (ou/s/m2)	<input type="text"/>
H2S Flux (ug/s/m2)	<input type="text"/>
NH3 Flux (ug/s/m2)	<input type="text"/>
Documentation	<input type="text"/>
Add a Control Technology	
Name of technology	<input type="text"/>
Odor reduction (%)	<input type="text"/>
H2S reduction (%)	<input type="text"/>
NH3 Reduction (%)	<input type="text"/>
Documentation	<input type="text"/>

Area Sources	
Add a Source Type	
Name of Source	<input type="text"/>
Odor Flux (ou/s/m2)	<input type="text"/>
H2S Flux (ug/s/m2)	<input type="text"/>
NH3 Flux (ug/s/m2)	<input type="text"/>
Documentation	<input type="text"/>
Add Control Technology	
Name of technology	<input type="text"/>
Odor reduction (%)	<input type="text"/>
H2S reduction (%)	<input type="text"/>
NH3 Reduction (%)	<input type="text"/>
Documentation	<input type="text"/>

Odors From Feedlots Setback Estimation Tool

OFFSET Ver 2.0
University of Minnesota
1/27/2017

Farm Name
 Address or County
 Evaluator
 Date

Clear All

OFFSET
Annoyance-free
98%

Source Edge to Nearest Neighbor (ft)
 Source Edge to Property Line (ft)

Building Sources

Building Type	Width (ft)	Length (ft)	# of Similar Sources	Total Area (sqft)	Control Technology	% air treated
Swine Finishing - deep pit ▼	185	153	1	28305	None ▼	
None ▼				0	None ▼	
None ▼				0	None ▼	
None ▼				0	None ▼	
None ▼				0	None ▼	
None ▼				0	None ▼	
None ▼				0	Biofilter ▼	

AREA SOURCES

Source Description	Shape	Width (ft) (or Dia)	Length (ft)	Area (sqft)	Control Technology
Earthen manure storage ▼	Rectangle ▼			0	None ▼
User added ▼	Rectangle ▼			0	None ▼
None ▼	Rectangle ▼			0	None ▼
None ▼	Rectangle ▼			0	None ▼
None ▼	Rectangle ▼			0	None ▼
None ▼	Rectangle ▼			0	None ▼
None ▼	Rectangle ▼			0	None ▼

Building Sources	
Add Source Type	
Name of Source	<input type="text"/>
Odor Flux (ou/s/m2)	<input type="text"/>
H2S Flux (ug/s/m2)	<input type="text"/>
NH3 Flux (ug/s/m2)	<input type="text"/>
Documentation	<input type="text"/>
Add a Control Technology	
Name of technology	<input type="text"/>
Odor reduction (%)	<input type="text"/>
H2S reduction (%)	<input type="text"/>
NH3 Reduction (%)	<input type="text"/>
Documentation	<input type="text"/>

Area Sources	
Add a Source Type	
Name of Source	<input type="text"/>
Odor Flux (ou/s/m2)	<input type="text"/>
H2S Flux (ug/s/m2)	<input type="text"/>
NH3 Flux (ug/s/m2)	<input type="text"/>
Documentation	<input type="text"/>
Add Control Technology	
Name of technology	<input type="text"/>
Odor reduction (%)	<input type="text"/>
H2S reduction (%)	<input type="text"/>
NH3 Reduction (%)	<input type="text"/>
Documentation	<input type="text"/>

Odors From Feedlots Setback Estimation Tool

OFFSET Ver 2.0
University of Minnesota
2010

Farm Name
 Address or County
 Evaluator
 Date

Clear All

OFFSET
Annoyance-free
98%

Source Edge to Nearest Neighbor (ft)
 Source Edge to Property Line (ft)

Building Sources

Building Type	Width (ft)	Length (ft)	# of Similar Sources	Total Area (sqft)	Control Technology	% air treated
Swine Finishing - deep pit ▼	185	153	1	28305	None ▼	
None ▼				0	None ▼	
None ▼				0	None ▼	
None ▼				0	None ▼	
None ▼				0	None ▼	
None ▼				0	None ▼	
None ▼				0	Biofilter ▼	

AREA SOURCES

Source Description	Shape	Width (ft) (or Dia)	Length (ft)	Area (sqft)	Control Technology
Earthen manure storage ▼	Rectangle ▼			0	None ▼
User added ▼	Rectangle ▼			0	None ▼
None ▼	Rectangle ▼			0	None ▼
None ▼	Rectangle ▼			0	None ▼
None ▼	Rectangle ▼			0	None ▼
None ▼	Rectangle ▼			0	None ▼
None ▼	Rectangle ▼			0	None ▼

Building Sources	
Add Source Type	
Name of Source	<input type="text"/>
Odor Flux (ou/s/m2)	<input type="text"/>
H2S Flux (ug/s/m2)	<input type="text"/>
NH3 Flux (ug/s/m2)	<input type="text"/>
Documentation	<input type="text"/>
Add a Control Technology	
Name of technology	<input type="text"/>
Odor reduction (%)	<input type="text"/>
H2S reduction (%)	<input type="text"/>
NH3 Reduction (%)	<input type="text"/>
Documentation	<input type="text"/>

Area Sources	
Add a Source Type	
Name of Source	<input type="text"/>
Odor Flux (ou/s/m2)	<input type="text"/>
H2S Flux (ug/s/m2)	<input type="text"/>
NH3 Flux (ug/s/m2)	<input type="text"/>
Documentation	<input type="text"/>
Add Control Technology	
Name of technology	<input type="text"/>
Odor reduction (%)	<input type="text"/>
H2S reduction (%)	<input type="text"/>
NH3 Reduction (%)	<input type="text"/>
Documentation	<input type="text"/>

Odors From Feedlots Setback Estimation Tool

Farm Name
Address or County
Evaluator
Date

Clear All

OFFSET Ver 2.0
 University of Minnesota
 02/12/17

OFFSET
Annoyance-free
95%

Source Edge to Nearest Neighbor (ft)
Source Edge to Property Line (ft)

Building Sources

Building Type	Width (ft)	Length (ft)	# of Similar Sources	Total Area (sqft)	Control Technology	% air treated
Swine Finishing - deep pit ▼	185	153	1	28305	None ▼	
None ▼				0	None ▼	
None ▼				0	None ▼	
None ▼				0	None ▼	
None ▼				0	None ▼	
None ▼				0	None ▼	
None ▼				0	Biofilter ▼	

AREA SOURCES

Source Description	Shape	Width (ft) (or Dia)	Length (ft)	Area (sqft)	Control Technology
Earthen manure storage ▼	Rectangle ▼			0	None ▼
User added ▼	Rectangle ▼			0	None ▼
None ▼	Rectangle ▼			0	None ▼
None ▼	Rectangle ▼			0	None ▼
None ▼	Rectangle ▼			0	None ▼
None ▼	Rectangle ▼			0	None ▼
None ▼	Rectangle ▼			0	None ▼

Building Sources	
Add Source Type	
Name of Source	<input type="text"/>
Odor Flux (ou/s/m2)	<input type="text"/>
H2S Flux (ug/s/m2)	<input type="text"/>
NH3 Flux (ug/s/m2)	<input type="text"/>
Documentation	<input type="text"/>
Add a Control Technology	
Name of technology	<input type="text"/>
Odor reduction (%)	<input type="text"/>
H2S reduction (%)	<input type="text"/>
NH3 Reduction (%)	<input type="text"/>
Documentation	<input type="text"/>

Area Sources	
Add a Source Type	
Name of Source	<input type="text"/>
Odor Flux (ou/s/m2)	<input type="text"/>
H2S Flux (ug/s/m2)	<input type="text"/>
NH3 Flux (ug/s/m2)	<input type="text"/>
Documentation	<input type="text"/>
Add Control Technology	
Name of technology	<input type="text"/>
Odor reduction (%)	<input type="text"/>
H2S reduction (%)	<input type="text"/>
NH3 Reduction (%)	<input type="text"/>
Documentation	<input type="text"/>

Redwood County Swine Composting Protocol:

- I. Purpose and scope: To allow hog producers to compost their dead livestock (carcasses) in lieu of rendering. These guidelines are based upon Minnesota Rules 1719 (Board of Animal Health), which are incorporated herein by reference. In any instance where these guidelines diverge from Minnesota Rules 1719, the stricter rule shall control.
- II. Site selection – must take into account:
 - a. Prevailing winds – reasonable attempts must be made to avoid sites where the prevailing winds will carry odors onto neighboring land uses (excepting agricultural fields and feedlots).
 - b. Public view – the compost facility must be shielded from public view, so that the composting material is not visible from public roadways or neighboring land uses.
- III. Facility – requirements for construction:
 - a. Overall design: Compost facility must consist of at least three (3) compost bays each with 20 cubic feet of area for every one (1) pound daily normal mortality. Each bay must have poured concrete walls on three sides and be gated on the front so that wild and domestic animals cannot access the compost. The entire structure must sit on a concrete pad and have a roof to deflect rainwater from the compost.
 - b. Floor: Floor must be constructed of 5” thick impervious concrete. Floor must be sloped toward the rear of the facility to keep liquid from running out of the composting area onto the ground.
 - c. Walls: Walls must be constructed of 6” thick impervious concrete. Cement walls must be no more than 5’ high. If lower than 5’, the walls must include fencing up to 5’ to prevent wild or domestic animals from accessing the compost. Cement walls must be high enough to contain the compost material.
 - d. Roof: Roof must be supported by treated wood or metal supports and rafters. Roof must completely cover the composting bays so as to deflect rainwater.
- IV. Process – the following practices must be observed:
 - a. Dead pigs must be added within 24 hours of death.
 - b. Each composting bay shall begin with a 1’ layer of litter. Thereafter, carcasses shall be stacked up to 1’ and covered by 1’ of litter. Add additional layers as needed.
 - c. Litter can be finely chopped vegetable matter (such as corn stalks), sawdust, or finished compost. The carbon to nitrogen ratio must be in the range of 15:1 to 35:1.
 - d. Carcasses must be kept at least 6” from the edge of the compost bay.
 - e. The 3 compost bays allow for a three stage composting process. When the first bay is full, start a new pile in the second bay. When the second bay is full, start a new pile in the third bay. When the third bay is full, empty the first bay and start over. Turn each bay every 7 to 10 days. Add water as necessary to keep up the heat.
 - f. Temperature:
 - i. Must be taken and recorded in each bay daily.
 - ii. Must be at least 130 degrees Fahrenheit.
 - iii. Temperature records must be kept on hand for 2 years.
- V. Protocol:
 - a. Must keep a written composting protocol describing the composting steps on-site.
 - b. Must instruct all employees on-site about the protocol.
- VI. Pests, such as flies and rodents, must be controlled
- VII. Transportation of Carcasses on public roads:
 - a. An owner who transports the owner’s own carcasses does not need a permit to do so.
 - b. Carcasses transported on public roads must be in leak-proof, covered containers.
- VIII. Finished compost:
 - a. Must contain no visible soft tissue pieces.
 - b. May be handled and stored according to PCA and Dept. of Agriculture rules.

Conditions for Permit No. 5-18 (Jon Schilling)

1. The permit holder shall comply with all applicable laws, rules, and regulations, including but not limited to Redwood County Ordinance, as hereafter amended from time to time. A copy of all required local, state, and federal permits and/or licenses shall be provided to the Redwood County Environmental Office upon request.
2. The permit holder shall allow the Redwood County Environmental Office to inspect the site for all purposes permitted by law whenever deemed necessary by the Redwood County Environmental Office.
3. The permit holder shall take appropriate and reasonable measures to assure that all surface water runoff satisfies all applicable local, state, and federal discharge standards.
4. The permit holder shall not allow the conditional use to be injurious to the use and enjoyment of other property in the immediate vicinity for the purposes already permitted. The permit holder shall not allow the conditional use to impede the normal and orderly development and improvement of surrounding vacant property for uses predominant to the area. Adequate measures shall be taken to prevent or control offensive odor, fumes, dust, and vibration, so that none of the foregoing will constitute a nuisance now or in the future.
5. Adequate utilities, access roads, drainage, and other necessary facilities will be provided and continue to be provided by the permit holder now and in the future.
6. The manner in which manure is stored and disposed of shall comply with all applicable local, state, and federal laws, rules, and regulations. If manure is applied to land, it shall be applied to land at agronomic rates. When applied to land, manure will be injected or incorporated within 24 hours. The permit holder shall retain a record of all locations where manure is applied to land. Such records shall be maintained for a period of no less than five (5) years, measured from the date the manure is applied to land. Such records shall be submitted to the Redwood County Environmental Office upon request.
7. The permit holder shall report any changes in spread agreements or spread areas to the Redwood County Environmental Office within thirty (30) days subsequent to any such change.
8. The County Board of Commissioners may at any time impose additional conditions as necessary and appropriate including but not limited to: the planting of trees and shrubs for use as a windbreak for the feedlot operation; the furnishing and placing in a dedicated account, to be administered by the County, an annual payment for reclamation purposes based upon the number of Animal Units involved; and restrictions on the days on which a manure storage structure may be disturbed or manure may be transferred, applied, incorporated, or injected.
9. Dead livestock shall be stored and rendered in such a manner as to not create a nuisance. Disposal of dead livestock by burial is strictly prohibited. Dead hogs may be composted according to the Redwood County Swine Composting Protocol.

10. The permit holder shall construct the manure storage structure/concrete pit(s) to meet or exceed the minimum requirements set forth in the plans and specifications prepared by Nicholaus J. Rowe and signed by him on February 22, 2018, attached to the permit holder's application.
11. A perimeter tile line shall be installed around the outside of the base of the pit(s) walls and an inspection manhole shall be provided where the perimeter tile branches out into the local drain tile system.
12. The permit holder shall install a warning sign at all entrances to the concrete pits. These signs shall warn the reader of the dangers of entering the pits.
13. The Redwood County Environmental Office shall be contacted for two on-site inspections during the construction of the pits: once when the floor is ready to be poured, and once when the walls are ready to be poured.
14. No construction on the pit shall be done between October 15th and April 15th, except by approval of the Zoning Administrator.
15. A setback of at least 50 feet shall be maintained between all feedlot structures and any county tile line. In the event that the Redwood County Ditch Authority, as represented by the Redwood County Ditch Inspector, determines that repairs are necessary to maintain county drain tile present on the feedlot site, the permit holder will be solely responsible, and hold the Redwood County Ditch Authority and Redwood County harmless, for any damage caused to any feedlot structure, driveway, parking area, or other improvement.
16. The Redwood County Planning Commission shall review the conditional use permit and shall be authorized to take any and all necessary action(s), including but not limited to revoking the conditional use permit and/or requiring the permit holder to reapply for a conditional use permit, if: 1) The Redwood County Environmental Office acquires information previously unavailable that indicates the terms and conditions of the permit do not accurately represent the actual circumstances of the permitted facility or the conditional use; 2) It is discovered subsequent to the issuance of the permit the permit holder failed to disclose all facts relevant to the issuance of the permit or submitted false or misleading information to the Redwood County Environmental Office, the Redwood County Planning Commission, or the Redwood County Board of Commissioners; 3) The Redwood County Environmental Office determines the permitted facility or conditional use endangers human health or the environment; and/or (4) The permit holder violates any of the herein described conditions, the Redwood County Ordinances, State statutes, or Federal laws.



REDWOOD COUNTY ENVIRONMENTAL OFFICE

*Planning & Zoning ● Parks & Trails ● GIS
Aquatic Invasive Species ● Septic Inspector
Drainage Inspector ● Agricultural Inspector*

**PO BOX 130
REDWOOD FALLS
MINNESOTA 56283
PH: 507-637-4023**

REDWOOD COUNTY PLANNING COMMISSION

**Jon Schilling
Conditional Use Permit Application #5-18
May 21st, 2018**

FINDINGS OF FACT

ORDINANCE CRITERIA – The Planning Commission may recommend the granting of a Conditional Use Permit in any district provided the proposed use is listed as a conditional use for the district and upon a showing that the standards and criteria stated in this Ordinance will be satisfied and that the use is in harmony with the general purposes and intent of this Ordinance and the Comprehensive Plan.

In determining whether the proposed use is in harmony with the general purposes and intent of the Ordinance and the Comprehensive Plan, the Planning Commission shall consider and make findings on the following questions:

- 1) Will the conditional use be injurious to the use and enjoyment of other property in the immediate vicinity for the purposes already permitted, or substantially diminish and impair property values within the immediate vicinity?

Yes _____ No _____

Why?: _____

- 2) Will the establishment of the conditional use impede on the normal and orderly development and improvement of surrounding vacant property for uses predominant to the area?

Yes _____ No _____

Why?: _____

3) Are there, or will there be provided, adequate utilities, access roads, drainage, and other necessary facilities?

Yes _____ No _____

Why?: _____

4) Have adequate measures been taken, or will adequate measures be taken, to provide sufficient off-street parking and loading space to serve the proposed use of the property?

Yes _____ No _____

Why?: _____

5) Have adequate measures been taken, or will adequate measures be taken, to prevent or control offensive odor, fumes, dust, noise and vibration, so that none of these will constitute a nuisance, and to control lighted signs and other lights in such a manner that no disturbance to neighboring properties will result?

Yes _____ No _____

Why?: _____

6) Will the proposed use have an impact (adverse) on the health, safety, and general welfare of the residents in the surrounding neighborhood?

Yes _____ No _____

Why?: _____

NAME: _____

DATE: _____



REDWOOD COUNTY ENVIRONMENTAL OFFICE

*Planning & Zoning • Parks & Trails • GIS
Aquatic Invasive Species • Septic Inspector
Drainage Inspector • Agricultural Inspector*

PO BOX 130
REDWOOD FALLS
MINNESOTA 56283
PH: 507-637-4023

TO: Whom It May Concern

FROM: Nick Brozek *NB*
Land Use and Zoning Supervisor
Redwood County Environmental Office

DATE: May 4th, 2018

RE: Notice of Public Hearing on Animal Confinement Feedlot Conditional Use Permit Application

Please find enclosed a *Notice of Public Hearing* regarding an *Animal Confinement Feedlot Conditional Use Permit Application* filed by Jon Schilling o/b/o landowner Thomas Schilling, pursuant to Minnesota Statute 116.07 subd. 7(a) and Section 17, Subd. 3 and Section 25 of Redwood County Zoning Ordinance, for the construction and operation of a new swine feedlot. The proposed feedlot will consist of one total confinement barn housing 3300 head of swine between 55 and 300 pounds in weight (990 State Animal Units, or 1320 County Animal Units), with under floor concrete liquid manure storage, on the following described property, situated in the County of Redwood, State of Minnesota, to wit:

The Southwest Quarter (SW1/4), except 10.1 acre tract, of Section 32, Township 110 North, Range 36 West, Willow Lake Township.

A public hearing thereon will be held before the Redwood County Planning Commission at the regularly scheduled Planning Commission meeting starting at 1:00 o'clock p.m. on Monday, the 21st day of May, 2018, at the Board Room of the Redwood County Government Center located at 403 South Mill Street, Redwood Falls, MN 56283.

Pursuant to Redwood County Zoning Ordinance, all property owners of record within five hundred (500) feet in incorporated areas and/or one-quarter (1/4) of a mile of the affected property or the ten (10) properties nearest to the affected property, whichever would provide notice to the greatest number of landowners in the unincorporated areas, the township in which the affected property is located, and all municipalities within two (2) miles of the property are required to be notified in writing of the time and place of the public hearing.

If you have any comments or questions regarding this matter, please contact the Redwood County Environmental Office by telephone at (507) 637-4023 or in writing at *Redwood County Environmental Office, P.O. Box 130, Redwood Falls, MN 56283*, and/or attend the Public Hearing at the time and date set forth in the *Notice of Public Hearing* enclosed herein.

Enclosure

Cc: Jon Schilling (w/ encl)
Thomas Schilling (w/ encl)



REDWOOD COUNTY ENVIRONMENTAL OFFICE

*Planning & Zoning • Parks & Trails • GIS
Aquatic Invasive Species • Septic Inspector
Drainage Inspector • Agricultural Inspector*

PO BOX 130
REDWOOD FALLS
MINNESOTA 56283
PH: 507-637-4023

NOTICE OF PUBLIC HEARING

An *Animal Confinement Feedlot Conditional Use Permit Application* has been filed by Jon Schilling o/b/o landowner Thomas Schilling, pursuant to Minnesota Statute 116.07 subd. 7(a) and Section 17, Subd. 3 and Section 25 of Redwood County Zoning Ordinance, for the construction and operation of a new swine feedlot. The proposed feedlot will consist of one total confinement barn housing 3300 head of swine between 55 and 300 pounds in weight (990 State Animal Units, or 1320 County Animal Units), with under floor concrete liquid manure storage, on the following described property, situated in the County of Redwood, State of Minnesota, to wit:

The Southwest Quarter (SW1/4), except 10.1 acre tract, of Section 32, Township 110 North, Range 36 West, Willow Lake Township.

A public hearing thereon will be held before the Redwood County Planning Commission at the regularly scheduled Planning Commission meeting starting at 1:00 o'clock p.m. on Monday, the 21st day of May, 2018, at the Board Room of the Redwood County Government Center located at 403 South Mill Street, Redwood Falls, MN 56283.

If you have any comments or questions regarding this matter, please contact the Redwood County Environmental Office by telephone at (507) 637-4023 or in writing at *Redwood County Environmental Office, P.O. Box 130, Redwood Falls, MN 56283.*

DATED: May 4th, 2018

Nicholas W. Brozek
Land Use & Zoning Supervisor
Redwood County Environmental Office

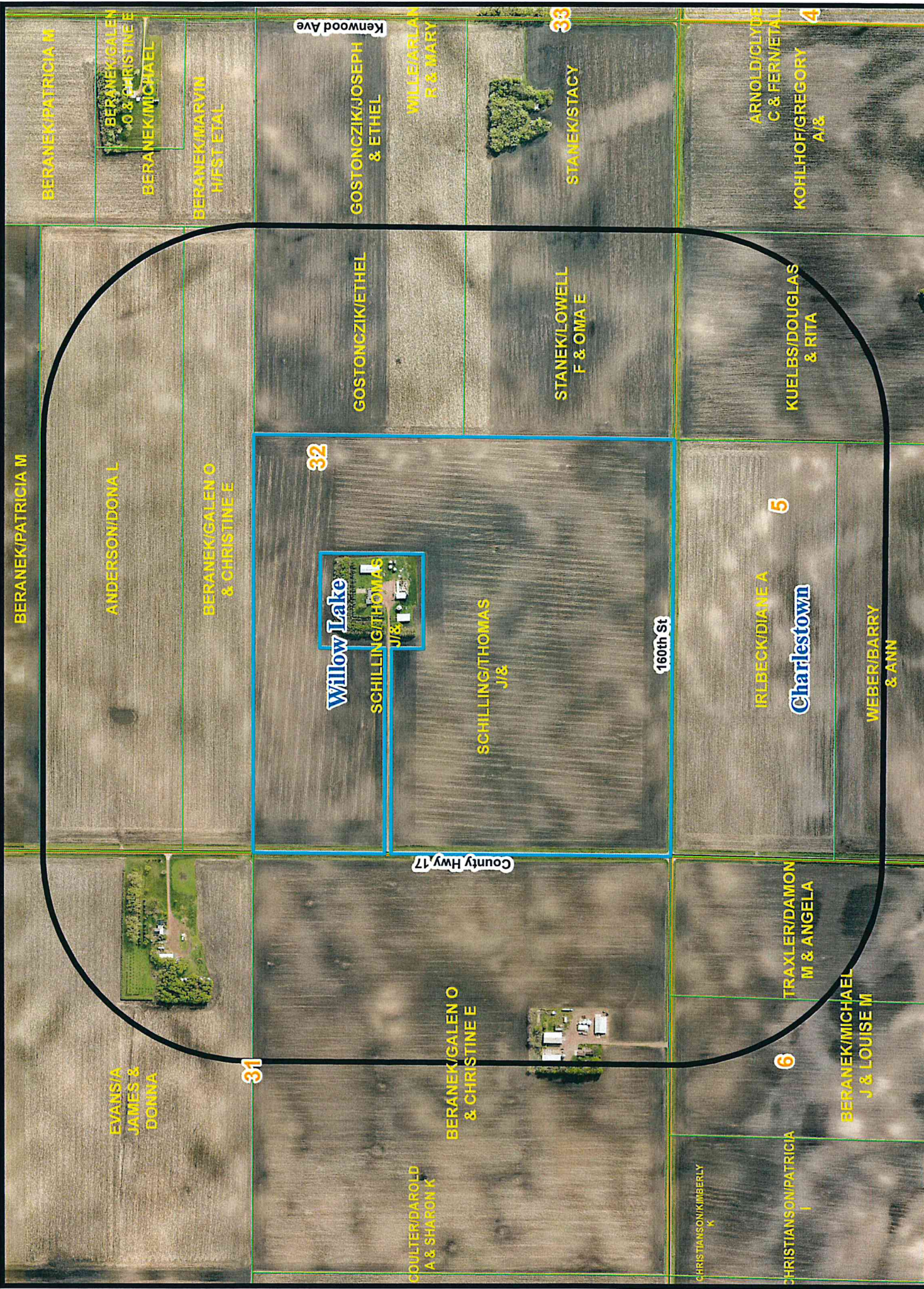

Legend

- CUP Notification Area
- CUP Parcel
- Township/ City
- Section
- Parcel
- Road

CUP Notification Area = 1/2 mile From CUP Parcel

Scale: 0 0.075 0.15 0.3 Miles

Compass: N, S, E, W

by enclosing a copy of the same in an envelope, with postage prepaid, and depositing said envelope in a United States Postal Service mailbox located at Redwood Falls, Minnesota on or about the 4th day of May, 2018.

Lali Ortega

Lali Ortega
Environmental Administrative Assistant

Subscribed and sworn to before me, a Notary Public, on this 4th day of May 2018, by Lali Ortega.

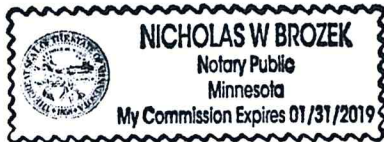

Nicholas W. Brozek

Notary Public